

Panasonic®

LCD Projector **Commercial Use**

Operating Instructions

ENGLISH

Model No. **PT-L785U**

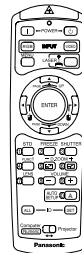
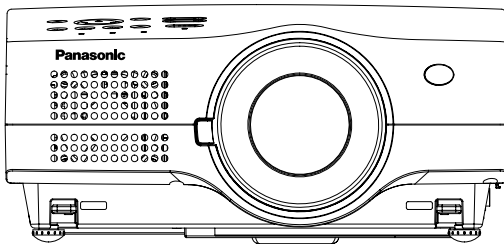

Before operating this product, please read the instructions carefully and save this manual for future use.

Dear Panasonic Customer:

This instruction booklet provides all the necessary operating information that you might require. We hope it will help you to get the most out of your new product, and that you will be pleased with your Panasonic LCD projector.

The serial number of your product may be found on its bottom. You should note it in the space provided below and retain this booklet in case service is required.

Model number: **PT-L785U**

Serial number: _____

IMPORTANT SAFETY NOTICE

WARNING: TO REDUCE THE RISK OF FIRE OR ELECTRIC SHOCK, DO NOT EXPOSE THIS PRODUCT TO RAIN OR MOISTURE.

Power Supply: This LCD Projector is designed to operate on 100 V – 240 V, 50 Hz/60 Hz AC, house current only.

CAUTION: The AC power cord which is supplied with the projector as an accessory can only be used for power supplies up to 125 V, 7 A. If you need to use higher voltages or currents than this, you will need to obtain a separate 250 V power cord. If you use the accessory cord in such situations, fire may result.

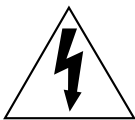

The lightning flash with arrowhead symbol, within an equilateral triangle, is intended to alert the user to the presence of uninsulated “dangerous voltage” within the product’s enclosure that may be of sufficient magnitude to constitute a risk of electric shock to persons.



The exclamation point within an equilateral triangle is intended to alert the user to the presence of important operating and maintenance (servicing) instructions in the literature accompanying the product.

CAUTION:

This equipment is equipped with a three-pin grounding-type power plug. Do not remove the grounding pin on the power plug. This plug will only fit a grounding-type power outlet. This is a safety feature. If you are unable to insert the plug into the outlet, contact an electrician. Do not defeat the purpose of the grounding plug.

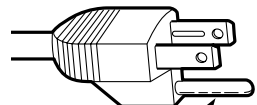

Do not remove

WARNING:

This equipment has been tested and found to comply with the limits for a Class B digital device, pursuant to Part 15 of the FCC Rules. These limits are designed to provide reasonable protection against harmful interference in a residential installation. This equipment generates, uses and can radiate radio frequency energy and, if not installed and used in accordance with the instructions, may cause harmful interference to radio communications. However, there is no guarantee that interference will not occur in a particular installation. If this equipment does cause harmful interference to radio or television reception, which can be determined by turning the equipment off and on, the user is encouraged to try to correct the interference by one or more of the following measures:

- Reorient or relocate the receiving antenna.
- Increase the separation between the equipment and receiver.
- Connect the equipment into an outlet on a circuit different from that to which the receiver is connected.
- Consult the dealer or an experienced radio/TV technician for help.

FCC CAUTION: To assure continued compliance, use only shielded interface cables when connecting to computers or peripheral devices.

Any unauthorized changes or modifications to this equipment will void the users authority to operate.

WARNING:

- Not for use in a computer room as defined in the Standard for the Protection of Electronic Computer/Data Processing Equipment, ANSI/NFPA 75.

Declaration of Conformity

Model Number: PT-L785U
 Trade Name: **Panasonic**
 Responsible party: Matsushita Electric Corporation of America.
 Address: One Panasonic Way Secaucus New Jersey 07094
 Telephone number: 1-800-528-8601 or 1-800-222-0741
 Email: pbtsservice@panasonic.com

This device complies with Part 15 of the FCC Rules, Operation is subject to the following two conditions: (1) This device may not cause harmful interference, and (2) this device must accept any interference received, including interference that may cause undesired operation.

Contents

Preparation

IMPORTANT SAFETY NOTICE ...	2
Precautions with regard to safety...	5
Accessories	9
Before use	10
Location and function of each part...	12

Getting started

Setting-up	18
Projection methods, Projector position, Projection distances	
Connections	20
Connecting to video equipment, Connecting to computer	
Preparation for the remote control unit	22
Setting the projector ID number for remote control unit	23

Basic operation

Turning on the power	24
Turning off the power	26

Useful functions

Correcting the image position automatically	28
Turning off the picture and sound momentarily	29
Pausing a picture	29
Enlarging the picture	30
Adjusting the volume	30
Adjusting the zoom and focus ...	31
Useful functions of the remote control unit	32
Laser beam pointer, Wireless mouse	

Adjustments and settings

On-screen menus	34
Menu screens, Menu operation guide, Returning a setting to the factory default	
Adjusting the picture	39
PICTURE MODE, CONTRAST, BRIGHT, COLOR, TINT, SHARPNESS, COLOR TEMP., Noise Reduction (NR), WHITE BALANCE R/G/B, TV-SYSTEM, Projecting sRGB-compatible pictures	
Adjusting the position	42
POSITION, DOT CLOCK, CLOCK PHASE, KEYSTONE, OSD	

POSITION, ASPECT, RESIZING, AUTO SETUP, FRAME LOCK

Audio adjustment	46
VOLUME, MUTE	
Changing the display language...	46
Option settings	47
OSD, AUTO SEARCH, AUTO SIGNAL, RGB2 SELECT, RGB/YPbPr, VGA60/480p, BACK COLOR, CINEMA REALITY, FRONT/REAR, DESK/CEILING, FAN CONTROL, LAMP POWER, LAMP RUN TIME, FUNC 1, CONTROL KEY, AUTO POWER OFF, SET ID	
Adjusting the lens	50
ZOOM/FOCUS, LENS SELECT	
Network setup	50
Setting up the security function...	51
PASSWORD SETTING, CHANGE PASSWORD, TEXT DISPLAY, CHANGE TEXT, LOGO DISPLAY, LOGO CLEAR, LOGO CAPTURE	

Care and maintenance

When the TEMP indicator and the LAMP indicator are illuminated...	54
Cleaning and replacing the air filter...	56
Replacing the lamp unit	57
Before calling for service.....	60
Cleaning and maintenance	61

Others

Using the cable cover	62
Putting the mains lead and remote control unit away, Covering the connector panel	
Replacing the projection lens ...	64
Projection distance for each projection lens (sold separately)	
Specifications	68
Appendix	70
List of compatible signals, Using the REMOTE connector, Using the SERIAL connector, Pin assignments, Projection dimensions calculation methods	
Dimensions	76
Trademark acknowledgements...	76
NOTES IMPORTANTES	
CONCERNANT LA SECURITE ..	77
Précautions de sécurité	78
Avant l'utilisation	82
Remplacement du bloc de lampe...	84

Precautions with regard to safety

WARNING

If you notice smoke, strange smells or noise coming from the projector, disconnect the power cord plug from the wall outlet.

- Do not continue to use the projector in such cases, otherwise fire or electric shocks could result.
- Check that no more smoke is coming out, and then contact an Authorized Service Center for repairs.
- Do not attempt to repair the projector yourself, as this can be dangerous.

Do not install this projector in a place which is not strong enough to take the full weight of the projector.

- If the installation location is not strong enough, it may fall down or tip over, and severe injury or damage could result.

Installation work (such as ceiling suspension) should only be carried out by a qualified technician.

- If installation is not carried out correctly, there is the danger that injury or electric shocks may occur.

If foreign objects or water get inside the projector, or if the projector is dropped or the cabinet is broken, disconnect the power cord plug from the wall outlet.

- Continued use of the projector in this condition may result in fire or electric shocks.
- Contact an Authorized Service Center for repairs.

Do not overload the wall outlet.

- If the power supply is overloaded (for example, by using too many adapters), overheating may occur and fire may result.

Do not remove the cover or modify it in any way.

- High voltages can cause fire or electric shocks.
- For any inspection, adjustment and repair work, please contact an Authorized Service Center.

Clean the power cord plug regularly to prevent it from becoming covered in dust.

- If dust builds up on the power cord plug, the resulting humidity can damage the insulation, which could result in fire. Pull the power cord plug out from the wall outlet and wipe it with a dry cloth.
- If not using the projector for an extended period of time, pull the power cord plug out from the wall outlet.

Do not do anything that might damage the power cord or the power cord plug.

- Do not damage the power cord, make any modifications to it, place it near any hot objects, bend it excessively, twist it, pull it, place heavy objects on top of it or wrap it into a bundle.
- If the power cord lead is used while damaged, electric shocks, short-circuits or fire may result.
- Ask an Authorized Service Center to carry out any repairs to the power cord that might be necessary.

Do not handle the power cord plug with wet hands.

- Failure to observe this may result in electric shocks.

Insert the power cord plug securely into the wall outlet.

- If the plug is not inserted correctly, electric shocks or overheating could result.
- Do not use plugs which are damaged or wall outlets which are coming loose from the wall.

Do not place the projector on top of surfaces which are unstable.

- If the projector is placed on top of a surface which is sloped or unstable, it may fall down or tip over, and injury or damage could result.

Do not place the projector into water or let it become wet.

- Failure to observe this may result in fire or electric shocks.

Do not place liquid containers on top of the projector.

- If water spills onto the projector or gets inside it, fire or electric shocks could result.
- If any water gets inside the projector, contact an Authorized Service Center.

Do not insert any foreign objects into the projector.

- Do not insert any metal objects or flammable objects into the projector or drop them onto the projector, as doing so can result in fire or electric shocks.

Keep the batteries out of the reach of infants.

- If the batteries are swallowed, death by suffocation may result. If you believe that the batteries may have been swallowed, seek medical advice immediately.

Do not allow the + and - terminals of the batteries to come into contact with metallic objects such as necklaces or hairpins.

- Failure to observe this may cause the batteries to leak, overheat, explode or catch fire.
- Store the batteries in a plastic bag and keep them away from metallic objects.

During a thunderstorm, do not touch the projector or the cable.

- Electric shocks can result.

Do not use the projector in a bath or shower.

- Fire or electric shocks can result.

Do not look into the lens while the projector is being used.

- Strong light is emitted from the projector's lens. If you look directly into this light, it can hurt and damage your eyes.
- Be especially careful not to let young children look into the lens. In addition, turn off the power and disconnect the power cord plug when you are away from the projector.

Keep the remote control unit out of the reach of children, and do not look into the laser beam or point it towards other people.

- If the laser beam which is emitted by the remote control unit transmitter is pointed directly into the eyes, it may cause visual ability to be impaired.

Do not place your hands or other objects close to the air outlet port.

- Heated air comes out of the air outlet port. Do not place your hands or face, or objects which cannot withstand heat close to this port, otherwise burns or damage could result.

Replacement of the lamp unit should only be carried out by a qualified technician.

- The lamp unit has high internal pressure. If improperly handled, explosion might result.
- The lamp unit can easily become damaged if struck against hard objects or dropped, and injury or malfunctions may result.

When replacing the lamp, allow it to cool for at least one hour before handling it.

- The lamp cover gets very hot, and contact with it can cause burns.

Before replacing the lamp, be sure to disconnect the power cord plug from the wall outlet.

- Electric shocks or explosions can result if this is not done.

Caution

Do not cover the air inlet port or the air outlet port.

- Doing so may cause the projector to overheat, which can cause fire or damage to the projector.
- Do not place the projector in narrow, badly ventilated places such as closets or bookshelves.

Do not set up the projector in humid or dusty places or in places where the projector may come into contact with smoke or steam.

- Using the projector under such conditions may result in fire or electric shocks.

When disconnecting the power cord, hold the plug, not the lead.

- If the power cord itself is pulled, the lead will become damaged, and fire, short-circuits or serious electric shocks may result.

Always disconnect all cables before moving the projector.

- Moving the projector with cables still attached can damage the cables, which could cause fire or electric shocks to occur.

Do not place any heavy objects on top of the projector.

- Failure to observe this may cause the projector to become unbalanced and fall, which could result in damage or injury.

Do not short-circuit, heat or disassemble the batteries or place them into water or fire.

- Failure to observe this may cause the batteries to overheat, leak, explode or catch fire, and burns or other injury may result.

When inserting the batteries, make sure the polarities (+ and -) are correct.

- If the batteries are inserted incorrectly, they may explode or leak, and fire, injury or contamination of the battery compartment and surrounding area may result.

Use only the specified batteries.

- If incorrect batteries are used, they may explode or leak, and fire, injury or contamination of the battery compartment and surrounding area may result.

Do not mix old and new batteries.

- If the batteries are inserted incorrectly, they may explode or leak, and fire, injury or contamination of the battery compartment and surrounding area may result.

Insulate the battery using tape or similar before disposal.

- If the battery comes into contact with metallic objects or other batteries, it may catch fire or explode.

Do not put your weight on this projector.

- You could fall or the projector could break, and injury may result.
- Be especially careful not to let young children stand or sit on the projector.

Do not lift up the projector by holding the cable cover.

- Failure to observe this may cause the cable cover to come off and the projector might fall, which could result in injury.

Disconnect the power cord plug from the wall outlet as a safety precaution before carrying out any cleaning.

- Electric shocks can result if this is not done.

Ask an Authorized Service Center to clean inside the projector at least once a year.

- If dust is left to build up inside the projector without being cleaned out, it can result in fire or problems with operation.
- It is a good idea to clean the inside of the projector before the season for humid weather arrives. Ask your nearest Authorized Service Center to clean the projector when required. Please discuss with the Authorized Service Center regarding cleaning costs.

We are constantly making efforts to preserve and maintain a clean environment. Please take non repairable units back to your dealer or a recycling company.

NOTICE:

- This product has a High Intensity Discharge (HID) lamp that contains a small amount of mercury. It also contains lead in some components. Disposal of these materials may be regulated in your community due to environmental considerations. For disposal or recycling information please contact your local authorities, or the Electronics Industries Alliance: <<http://www.eiae.org>>

Accessories

Check that all of the accessories shown below have been included with your projector.

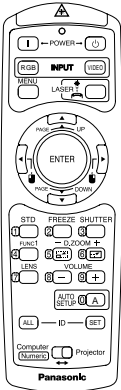
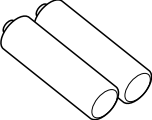
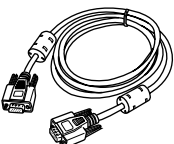
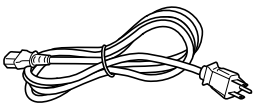
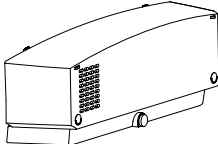
<p>Remote control unit (N2QAEA000022 x1)</p> 	<p>AAA batteries for remote control unit (x2)</p> 	<p>RGB signal cable [3.0 m (9'10"), K1HB15FA0001 x1]</p> 
	<p>Power cord (K2CG3FZ00008 x 1)</p> 	<p>Cable cover (TXFKR01VJX7 x1)</p> 

Before use

Caution when moving the projector

Be sure to attach the lens cover before moving the projector.

The projection lens is extremely susceptible to vibration and shocks. Be careful not to subject it to excessive vibration and shock when moving the projector.

Cautions regarding setting-up

Avoid setting up in places which are subject to vibration or shocks.

The internal parts can be damaged, which may cause malfunctions or accidents.

Do not set up the projector near high-voltage power lines or near motors.

The projector may be subject to electromagnetic interference.

If installing the projector to the ceiling, ask a qualified technician to carry out all installation work.

You will need to purchase the separate installation kit (Model No.ET-PK780). Furthermore, all installation work should only be carried out by a qualified technician.

If using this projector at high elevations (above 1 400 m), set the “FAN CONTROL” to “HIGH”. (Refer to page 48.)

Failure to observe this may result in malfunctions.

Notes on use

In order to get the best picture quality

Draw curtains or blinds over any windows and turn off any lights near the screen to prevent outside light or light from indoor lamps from shining onto the screen.

Do not touch the surfaces of the lens with your bare hands.

If the surface of the lens becomes dirty from fingerprints or anything else, this will be magnified and projected onto the screen. Moreover, when not using the projector, retract the lens and then cover it with the lens cover.

Screen

Do not apply any volatile substances which may cause discoloration to the screen, and do not let it become dirty or damaged.

Lamp

The lamp may need to be replaced earlier due to variables such as individual lamp characteristics, usage conditions and the installation environment, especially when the projector is subjected to continuous use for more than 10 hours or the power is frequently turned on and off, as the operations that prevent blackening of the bulb (the action of the halogen cycle) do not work enough during short periods of time.

Liquid crystal panel

The liquid crystal panel of the projector is built with very high precision technology to provide fine picture details. Occasionally, a few non-active pixels may appear on the screen as fixed points of blue, green or red. Please note that this does not affect the performance of your LCD.

Location and function of each part

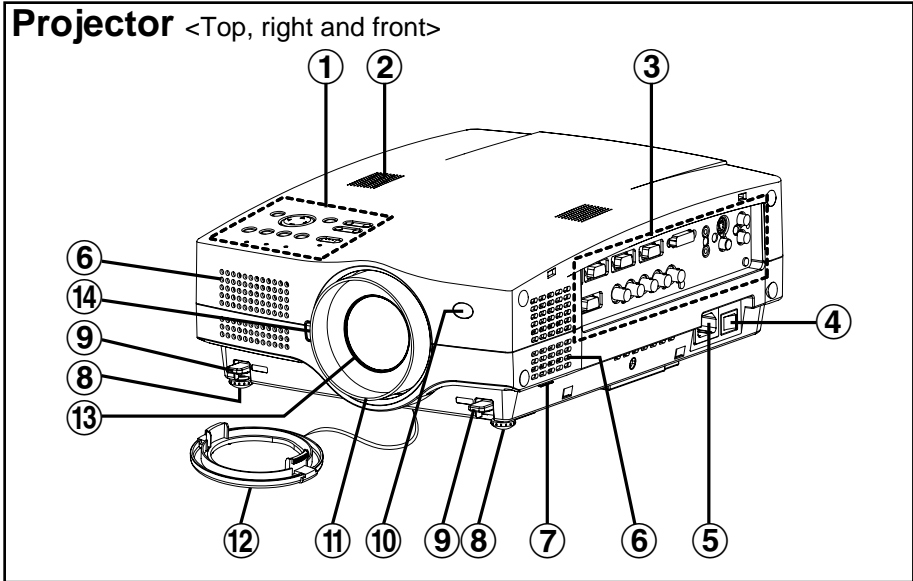

① **Projector control panel** (page 14)

② **Speaker**

③ **Connector panel** (page 16)

④ **MAIN POWER switch** (pages 24 and 26)

⑤ **Power input socket (AC IN)** (page 24)

The accessory power cord is connected here.

Do not use any power cord other than the accessory power cord.

⑥ **Air inlet ports**

Do not cover these ports.

⑦ **Air filter** (page 56)

⑧ **Front adjustable legs(L/R)** (page 25)

⑨ **Leg adjuster buttons(L/R)** (page 25)

These buttons are used to unlock the front adjustable legs. Press to adjust the angle of tilt of the projector.

⑩ **Remote control signal receptor** (page 22)

⑪ **Focus ring** (page 25)

⑫ **Lens cover**

⑬ **Projection lens**

⑭ **Lens release button** (page 64)

This button is used when using a projection lens that is sold separately.

Projector <Back and bottom>

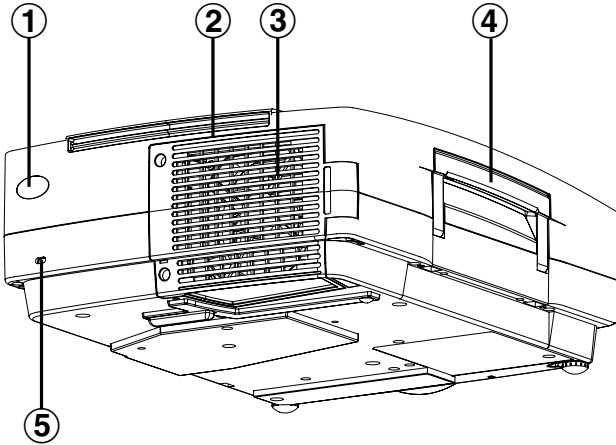

① **Remote control signal receptor** (page 22)

② **Lamp unit holder** (page 57)

③ **Air outlet port**
Do not cover this port.

④ **Carrying handle**

⑤ **Security lock**

This can be used to connect a commercially-available theft-prevention cable (manufactured by Kensington). This security lock is compatible with the Microsaver Security System from Kensington.

NOTE:

- During projection of an image, the cooling fan will operate, emitting a small noise as it operates. Turning the lamp on or off will cause this noise to increase a little.
- By using the “OPTION” menu to set “LAMP POWER” to “LOW”, the operating sound of the fan can be reduced. (Refer to page 48.)

WARNING

Do not place your hands or other objects close to the air outlet port.

- Heated air comes out of the air outlet port. Do not place your hands or face, or objects which cannot withstand heat close to this port, otherwise burns or damage could result.

Remote control unit

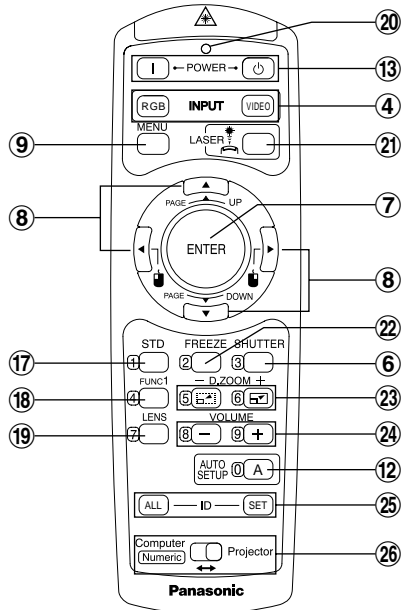
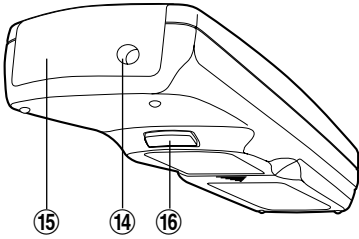

Projector control panel

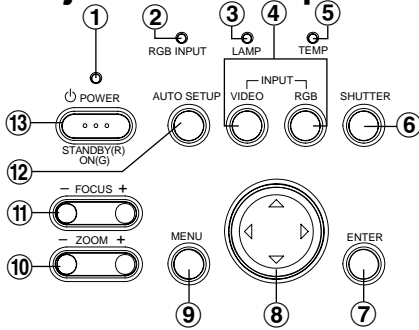

① Power indicator (pages 24, 26 and 27)

This indicator illuminates red when the MAIN POWER switch is turned on, and illuminates green when the power is turned on and a picture starts to be projected.

When the projector is in “WEB STANDBY” mode, this indicator flashes slowly in red.

② RGB INPUT indicator (page 27)

This indicator illuminates when a signal is input into the connector that is selected with the input select buttons.

③ LAMP indicator (page 55)

This indicator illuminates when it is time to replace the lamp unit. It flashes if a circuit abnormality is detected.

④ INPUT (RGB, VIDEO) buttons (page 25)

These buttons are used to select the input signals. When “AUTO SEARCH” in the “OPTION” menu is set to “ON”, the input signal will be detected and selected automatically by pressing this button for a few seconds. (Refer to page 47.)

⑤ TEMP indicator (page 54)

This indicator illuminates if an abnormally high temperature is detected inside the projector or around it. If the temperature rises above a certain level, the power supply will be turned off automatically and the indicator will flash.

⑥ SHUTTER button (page 29)

This button is used to momentarily turn off the picture and sound.

⑦ ENTER button (page 38)

This button is used to accept and to activate items selected in the on-screen menus.

*When in computer operating mode, this button on the remote control unit functions differently. (page 33)

⑧ **Arrow (▲▼◀ and ▶) buttons** (page 37)

These buttons are used to select and adjust items in the on-screen menus.

*When in computer operating mode, these buttons on the remote control unit function differently. (page 33)

⑨ **MENU button** (pages 34 and 37)

This button is used to display the menu screens. When a menu screen is being displayed, this button can be used to return to a previous screen or to clear the screen.

⑩ **ZOOM +/- buttons** (page 25)

These buttons are used to adjust the size of the projected image.

⑪ **FOCUS +/- buttons** (page 25)

These buttons are used to adjust the focus of the projected image.

⑫ **AUTO SETUP button** (pages 25 and 28)

If this button is pressed while a picture is being projected, the projection settings will be adjusted automatically in accordance with the signal being input.

⑬ **POWER button** (pages 24 and 26)

These buttons are used to turn the power on and off when MAIN POWER is turned on.

(For the remote control unit, the “|” button is for turning on the power and the “⏻” button is for turning off the power.)

⑭ **Laser emitter** (page 32)

⑮ **Infrared emitter** (page 22)

⑯ **Click button** (page 33)

This button can be used when the operating mode select switch is moved to the left (Computer).

⑰ **STD (standard) button** (page 38)

This button is used to reset the projector adjustment values to the factory default settings.

⑱ **FUNC1 button** (pages 43, 46 and 49)

This button can be used for 1) switching on and off the sound volume and 2) entering into the keystone distortion correction mode. Adjust “FUNC1” in the “OPTION” menu to select which you wish to use.

⑲ **LENS button** (page 31)

This button is used to display the zoom and focus adjustment screen.

⑳ **Operation indicator** (page 32)

This indicator illuminates while a laser beam is being emitted (while the LASER button is being pressed). It flashes when any other buttons are being pressed.

㉑ **LASER button** (page 32)

A beam of laser light is emitted while this button is being pressed. This laser beam can be used as a pointer to point to something on the screen.

㉒ **FREEZE button** (page 29)

This button is used to momentarily freeze projection so that a still picture is displayed.

㉓ **D.ZOOM +/- buttons** (page 30)

These buttons are used to enlarge the projected image.

(continued on next page)

(continued from previous page)

24 VOLUME +/- buttons (page 30)

These buttons are used to adjust the volume of the sound that is output from the projector's built-in speakers and AUDIO OUT connector. Refer to page 46 for details on how to adjust the volume using the buttons on the projector control panel.

25 ID SET/ALL button (page 23)

These buttons are used to set the projector ID number into the remote control unit when using multiple projectors with a single remote control unit.

26 Operating mode (Computer, Projector) select switch (page 33)

Move this switch to the left side to use the remote control unit to operate a computer, and move it to the right side to operate the projector.

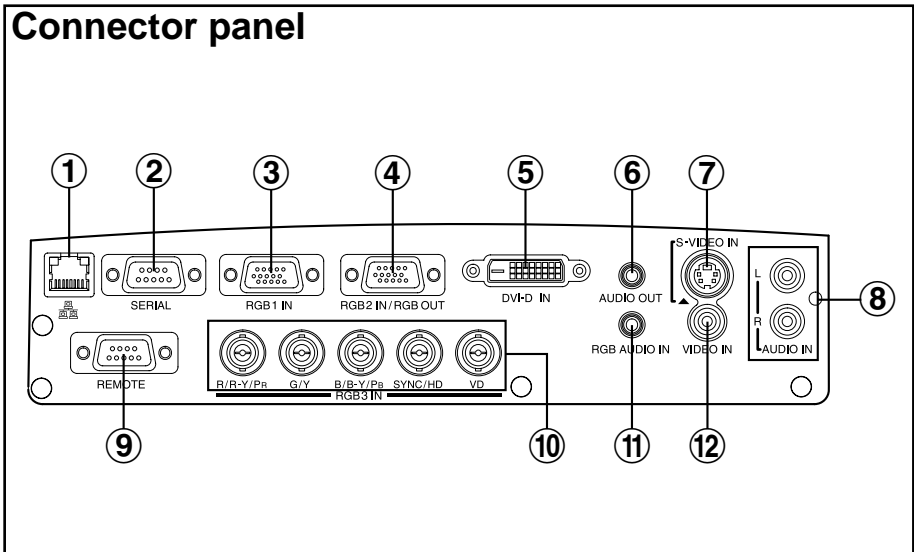

1 Wired LAN connector

This connector is used to connect a personal computer to the projector in order to externally control the projector. (10 Base-T/100 Base-TX)
Refer to the "Network Function Edition" operating instructions for details.

2 SERIAL connector (pages 20, 21 and 72)

This connector is used to connect a personal computer to the projector in order to externally control the projector. (RS-232C compatible)

3 RGB1 IN connector (pages 20 and 21)

This connector is used to input RGB signals and YPbPr signals.

- ④ **RGB2 IN/RGB OUT connector** (pages 20, 21 and 47)
This connector is used to input or output RGB signals and YPbPr signals. Adjust "RGB2 SELECT" in the "OPTION" menu to select whether you want input or output with this connector.
- ⑤ **DVI-D IN connector** (page 21)
This connector is used to input DVI-D signals.
- ⑥ **AUDIO OUT connector** (pages 20 and 21)
This connector is used to output the audio signals which are input to the projector. If audio equipment is connected to this connector, no sound will be output from the built-in speakers.
- ⑦ **S-VIDEO IN connector** (pages 20 and 45)
This connector is used to input signals from a S-VIDEO-compatible equipment such as a video deck. The connector is S1 signal compatible, and it automatically switches between 16:9 and 4:3 aspect ratios in accordance with the type of signal being input.
- ⑧ **AUDIO IN L-R connectors (for S-VIDEO/VIDEO)** (page 20)
Only one system is provided, so connect the appropriate connectors when using S-VIDEO or VIDEO.
- ⑨ **REMOTE connector** (page 71)
This connector is used to control the projector from the remote control set up in wired mode.
- ⑩ **RGB3 IN connector** (pages 20 and 21)
This connector is used to input RGB signals and YPbPr signals.
- ⑪ **RGB AUDIO IN connector** (pages 20 and 21)
Only one system is provided, so connect the appropriate connector when using RGB1, RGB2 or RGB3.
- ⑫ **VIDEO IN connector** (page 20)
This connector is used to input video signals from a video equipment such as a video deck.

Setting-up

Projection methods

In way of installing projector, any one of the following four projection methods are used. Select whichever projection method matches the setting-up method. (The projection method can be set from the "OPTION" menu. Refer to page 48 for details.)

● Front-desk projection

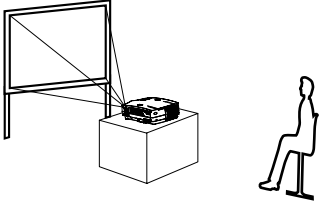

Menu items	Setting
FRONT/REAR	FRONT
DESK/CEILING	DESK

● Front-ceiling projection

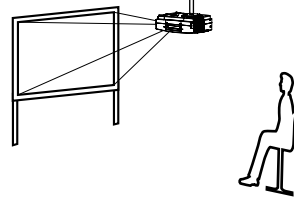

Menu items	Setting
FRONT/REAR	FRONT
DESK/CEILING	CEILING

● Rear-desk projection (Using a translucent screen)

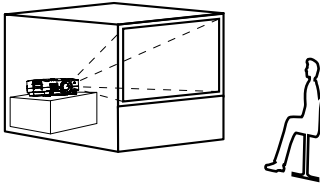

Menu items	Setting
FRONT/REAR	REAR
DESK/CEILING	DESK

● Rear-ceiling projection (Using a translucent screen)

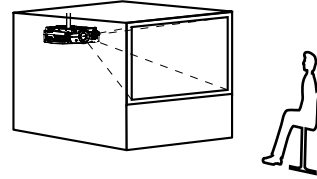

Menu items	Setting
FRONT/REAR	REAR
DESK/CEILING	CEILING

NOTE:

- You will need to purchase the separate ceiling bracket (ET-PK780) when using the ceiling installation method.
- If you set up the projector vertically, it may cause damage to the projector.
- It is recommended that you set up the projector in a place that is tilted at less than $\pm 30^\circ$. Setting up the projector in places that are tilted at more than $\pm 30^\circ$ may cause malfunctions.

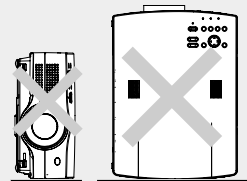

Projector position

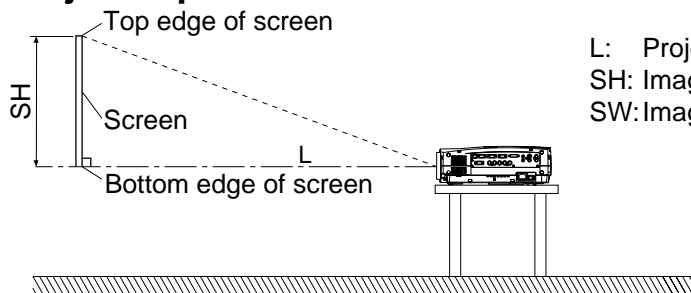

L: Projection distance
SH: Image height
SW: Image width

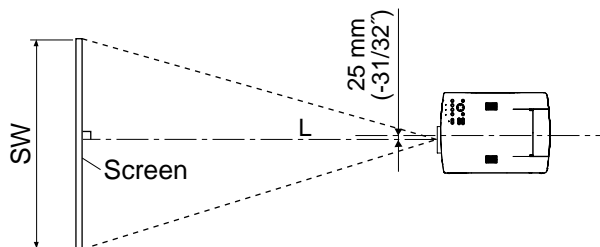

Projection distances*

Screen size (4:3)			Projection distance (L)	
Diagonal length	Height (SH)	Width (SW)	Wide (LW)	Telephoto (LT)
1.01 m(40")	0.61 m(2')	0.81 m(2'8")	1.6 m(5'2")	2.0 m(6'6")
1.27 m(50")	0.76 m(2'6")	1.02 m(3'4")	2.0 m(6'6")	2.6 m(8'6")
1.52 m(60")	0.91 m(3')	1.22 m(4')	2.4 m(7'10")	3.1 m(10'2")
1.77 m(70")	1.07 m(3'6")	1.42 m(4'8")	2.8 m(9'2")	3.6 m(11'9")
2.03 m(80")	1.22 m(4')	1.63 m(5'4")	3.2 m(10'5")	4.2 m(13'9")
2.28 m(90")	1.37 m(4'6")	1.83 m(6')	3.6 m(11'9")	4.7 m(15'5")
2.54 m(100")	1.52 m(5')	2.03 m(6'8")	4.0 m(13'1")	5.3 m(17'4")
3.81 m(150")	2.29 m(7'6")	3.05 m(10')	6.1 m(20')	7.9 m(25'11")
5.08 m(200")	3.05 m(10')	4.06 m(13'4")	8.1 m(26'6")	10.6 m(34'9")
6.35 m(250")	3.81 m(12'6")	5.08 m(16'8")	10.1 m(33'1")	13.3 m(43'7")
7.62 m(300")	4.57 m(15')	6.10 m(20')	12.2 m(40')	16.0 m(52'5")

*For standard lens which is supplied with the projector. Refer to pages 65 – 67 for details on the projection distances for the optional lenses.

NOTE:

- The dimensions in the table above are approximate.
- If you use the projection distance for the 16:9 screen, the 4:3 projection image overflows the screen at the top and bottom.
- For details about projected image distances, refer to page 75.

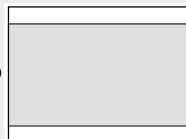

Connections

Notes on connections

- Read the instruction manual for each peripheral device carefully before connecting it.
- Turn off the power supply for all peripheral devices before making any connections.
- If the cables necessary for connection are not included with the peripheral device or available as an option, you may need to prepare a proper cable for the device concerned.
- If there is a lot of jitter in the video signal, the projected image may flicker. In such cases, it will be necessary to connect a TBC (time base corrector).
- Refer to the list on page 70 for details on compatible signals which can be input to the projector.
- Only one audio system circuit is available for each of the AUDIO IN L-R connectors for S-VIDEO/VIDEO signals and the RGB AUDIO IN connector, so if you wish to change the audio input source, you will need to remove and insert the appropriate plugs.

Connecting to video equipment

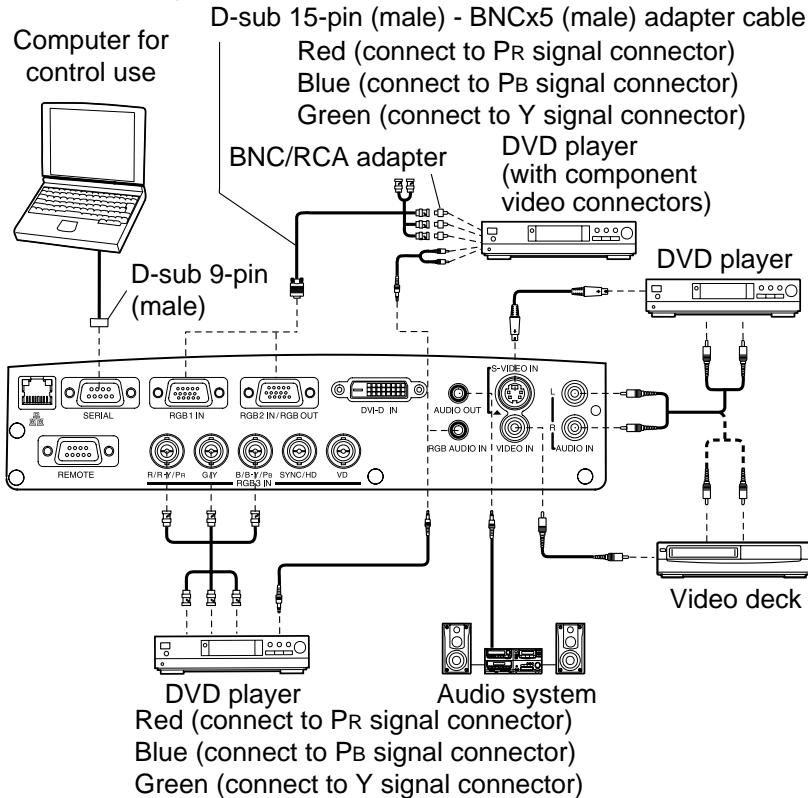

NOTE:

- If the signal cables are disconnected or if the power supply for the computer or video deck is turned off while "D.ZOOM"(digital zoom) is being used, this function will be cancelled.

Connecting to computer

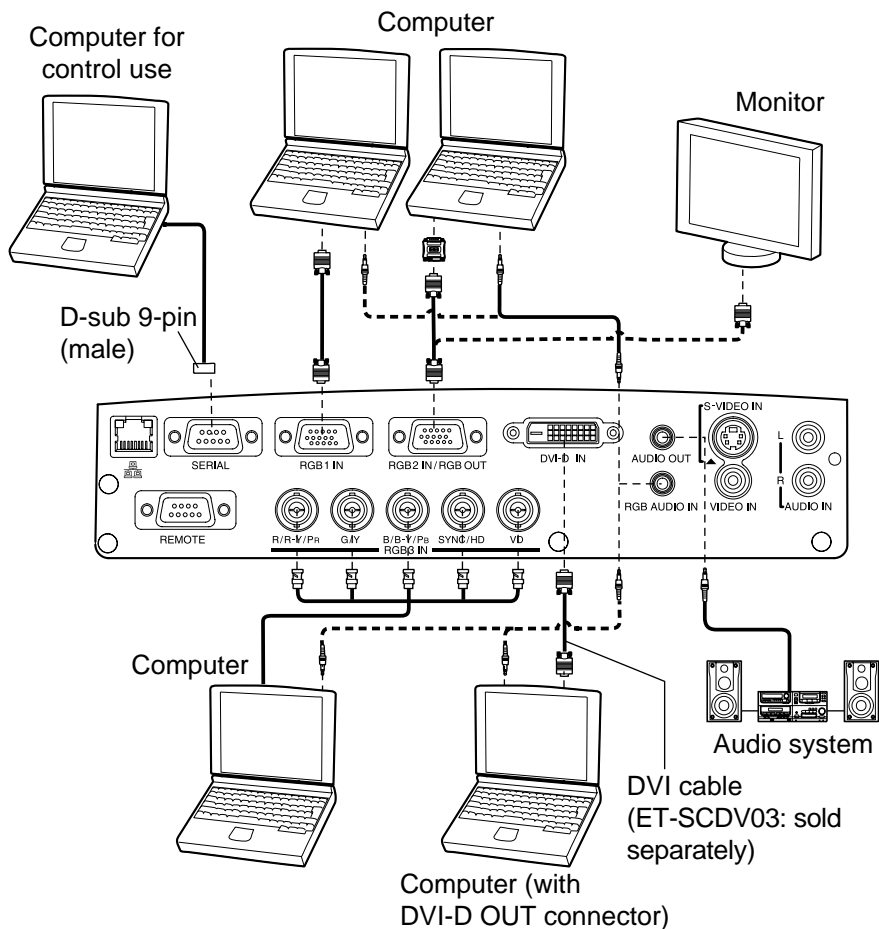

NOTE:

- Do not input the signal to the RGB2 IN/RGB OUT connector when “RGB2 SELECT” in the “OPTION” menu is set to “OUTPUT”. (Refer to page 47.)

Refer to the “Network Function Edition” operating instructions for details on connecting the projector to a personal computer using the wired LAN connector.

Preparation for the remote control unit

① Open the cover.

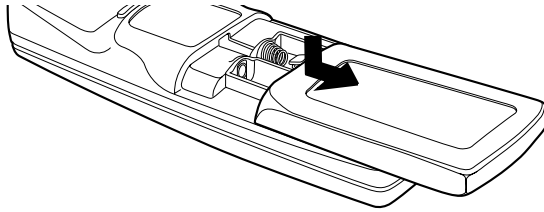

② Insert the batteries so that the polarities are correct, and then close the cover.

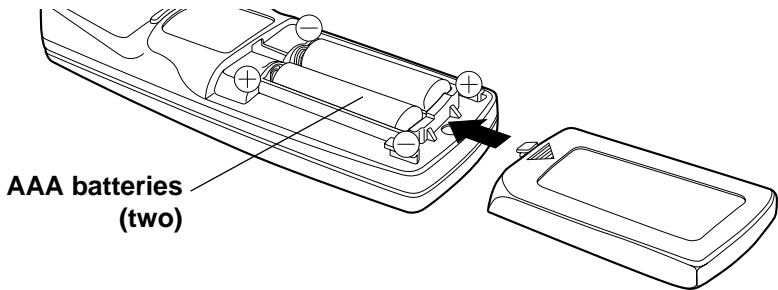

NOTE:

- Do not drop the remote control unit.
- Keep the remote control unit away from liquids.
- Remove the batteries if not using the remote control unit for long periods.
- Do not use rechargeable batteries.
- If the remote control unit is held so that it is facing directly in front of the remote control signal receptors on the front or rear of the projector, the operating range is within approximately 7 m (23') from the surfaces of the receptors. Furthermore, the remote control unit can be operated from an angle of $\pm 30^\circ$ to the left or right and $\pm 15^\circ$ above or below the receptors.
- If there are any obstacles in between the remote control unit and the receptors, the remote control unit may not operate correctly.
- If strong light is allowed to shine onto the remote control signal receptor, correct projector operation may not be possible. Place the projector as far away from light sources as possible.
- If facing the remote control unit toward the screen to operate the projector, the operating range of the remote control unit will be limited by the amount of light reflection loss caused by the characteristics of the screen used.

Setting the projector ID number for the remote control unit

When controlling multiple projectors individually or simultaneously with a single remote control unit, a projector ID number must be set into the remote control unit as described in the following steps.

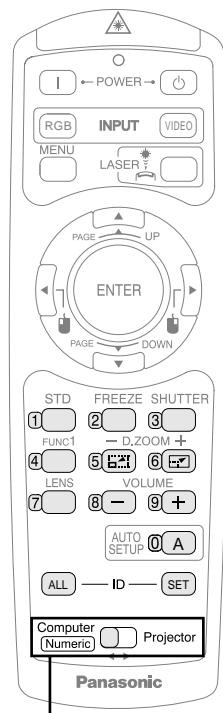

Mode switch

- ① **When setting the projector ID number, move the mode switch to the left side (Numeric).**
- ② **Press the ID SET button on the remote control unit.**
The projector ID number which is currently set will be displayed on the screen.
- ③ **Press the numeric (0 - 9) buttons on the remote control unit to set the ID number.**
The entered ID number will be displayed on the screen. (You can set from the number 1 to the number 64.)
 - If the entered ID number is 10 - 64, the ID number setting will be completed.
 - If the ID number entered is less than 10, press any button other than the numeric buttons or the ID SET/ALL button, or wait for about 5 seconds to complete the setting.

NOTE:

- If the entered ID number is more than 64, the ID number will return to the one set before the ID SET button was pressed.
- The ID number setting screen will be canceled if no number is entered for 5 seconds or if any button except the numeric buttons is pressed.
- If the ID SET button is pressed after a number less than 10 is entered, the entered number will be cancelled.
- If ID number is set to "ALL" by pressing the ID ALL button, the projectors can be controlled regardless of their ID number setting.
- The projector cannot be turned on and off from the remote control unit if the "CONTROLLER ID" does not match the projector ID number. For more details on projector ID number setting, see page 49.
- The projector ID number in the remote control unit is set to "ALL" by default. It is therefore not necessary to set a projector ID number when only one projector is used.

Turning on the power

Before turning on the power

- 1, Ensure that all peripheral devices are connected properly.
- 2, Connect the accessory power cord.
- 3, Remove the lens cover.

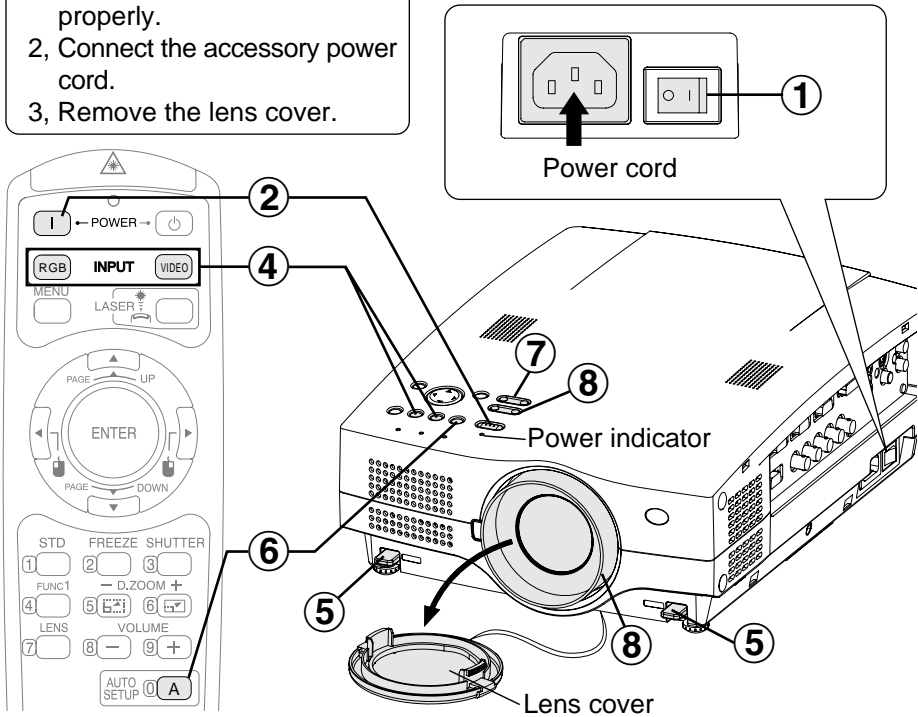

- 1 Press the MAIN POWER switch to turn on the power.**
 - The power indicator on the projector will illuminate red.
- 2 Press the POWER button.**
 - The power indicator on the projector will flash green. After a short period, the indicator will illuminate green, and a picture will be projected.
- 3 Turn on the power of all connected devices.**
 - Start the play function of a device such as a DVD player.

NOTE:

- A tinkling sound may be heard when the lamp unit is turned on, but this is not a sign of a malfunction.
- The projector cannot be turned on and off from the remote control unit if the "CONTROLLER ID" does not match the projector ID number. (pages 23 and 49)

④ Press the input select button to select the input signal.

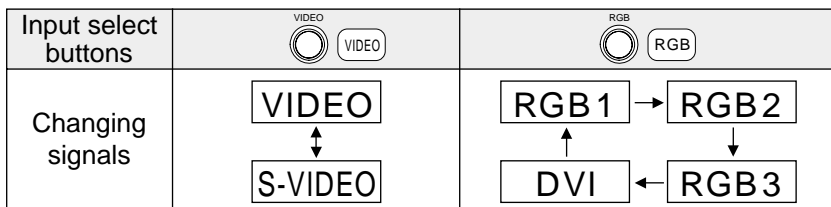

- A picture will be projected in accordance with the selected input signal.
- When an YPBPR signal is being input, “YPBPR” will be displayed (when “RGB/YPBPR” in the “OPTION” menu is set to “YPBPR”. Refer to page 47 for details).

Follow the procedure below when you set the projector up first, and when you change the setup place.

⑤ Adjusting the angle

- While pressing the adjuster buttons, adjust the forward/back angle of tilt of the projector. Adjust so that the projector is as vertical to the screen as possible.

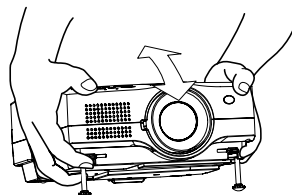

⑥ Press the AUTO SETUP button to initiate automatic positioning.

- The position of the projected image will be corrected automatically in accordance with the input signal. (Refer to page 28 for details.)
- If the projected image contains keystone distortion, adjust “KEystone” in the “POSITION” menu (refer to page 43 for details).



⑦ Adjusting the size

- Press the ZOOM +/- buttons to adjust the size of the projected image.

⑧ Adjusting the focus

- Press the FOCUS +/- buttons to adjust the focus of the projected image. The focus of the projected image can also be adjusted by turning the focus ring. To make fine adjustments, use the FOCUS +/- buttons.

Turning off the power

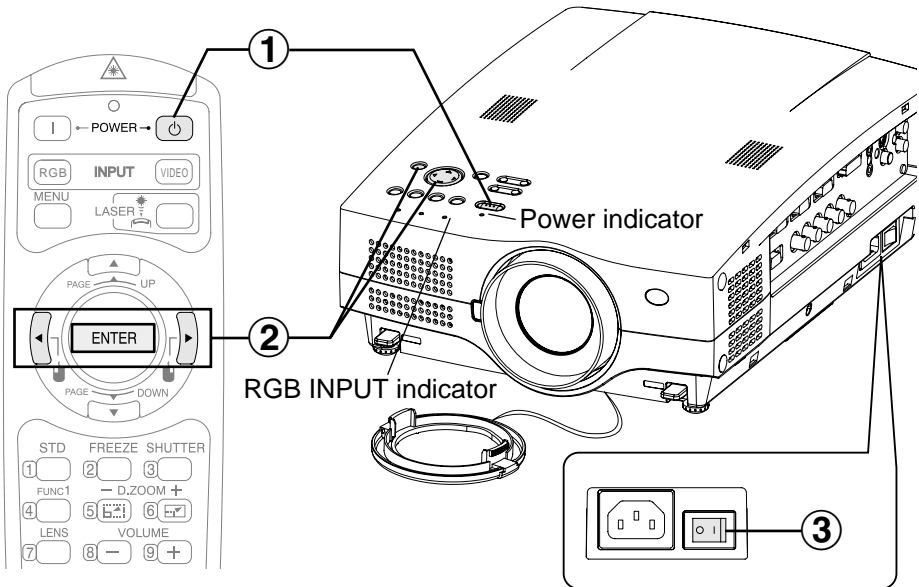

1 Press the **POWER** button.

- “Power OFF” is displayed on the screen.

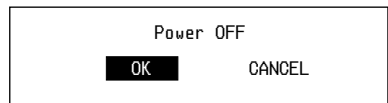

2 Press the ◀ or ▶ button to select “OK”, and then press the **ENTER** button.

- The lamp unit will switch off and the picture will stop being projected. (The power indicator on the projector will illuminate orange while the cooling fan is still operating.)

3 Press the **MAIN POWER** switch to turn off the power after the power indicator on the projector illuminates red.

Direct power off function

You can turn off the MAIN POWER switch and move the projector immediately after use. The cooling fan will operate by the internal power supply to cool down the lamp.

- When this function is used, it may take more time for the lamp to turn back on again compared to when the lamp cools down while the MAIN POWER switch is ON.
- Do not put the projector in a bag while the cooling fan is operating.

NOTE:

- You can also turn off the power by pressing the POWER button twice or by holding it down for at least 0.5 seconds.
- When the projector is in standby mode (the power indicator on the projector is illuminated red), the projector continues to draw approximately 11 W of power even when the cooling fan has stopped.
- When the projector is in “WEB STANDBY” mode, the cooling fan operates and the power indicator on the projector flashes slowly in red and the projector continues to draw approximately 40 W of power. (page 50)

Power indicator

Power indicator status		Projector status
Red	Illuminated	The projector is in standby mode and image projection is possible by pressing the POWER button.
	Flashing slowly	The projector is in “WEB STANDBY” mode, and can be controlled with personal computers via a wired LAN. (The cooling fan is operating.)
Green	Flashing	The projector is preparing for projection after the power is turned on while the power indicator is illuminated red. (After a short period, a picture will be projected.)
	Illuminated	A picture is being projected.
Orange	Illuminated	The lamp is cooling down after the power is turned off. (The cooling fan is operating.)
	Flashing	The projector is preparing for projection after the power is turned on while the power indicator is illuminated orange. (After a short period, a picture will be projected.)

RGB INPUT indicator

RGB INPUT indicator status	Projector status
Illuminated during standby mode	A signal is being input to one of the RGB1 IN, RGB2 IN or RGB3 IN connectors.
Illuminated during projection	A signal is being input to the connector selected using the input select buttons.

Correcting the image position automatically (AUTO SETUP)

The position of the projected image can be corrected automatically in accordance with the input signal.

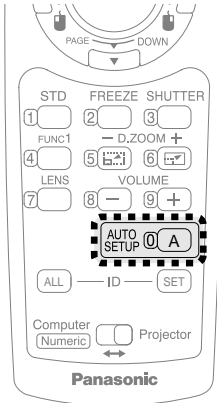

Projector control panel

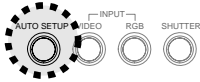

Press the AUTO SETUP button.

(When the edges of the projected image are not visible)

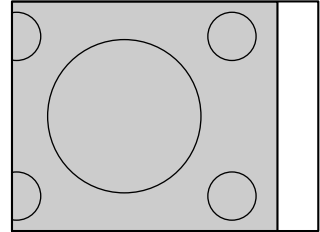

- Automatic positioning will be carried out.

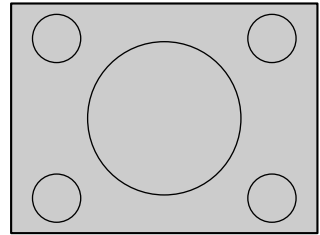

NOTE:

- "AUTO SETUP" does not function when DVI signals are being input.
- When RGB signals are being input, "DOT CLOCK", and "CLOCK PHASE" will be adjusted automatically in addition to the position of the image being corrected (except when the dot clock frequency is 108 MHz or higher). Refer to page 43 for details.
- If the edges of the projected image are indistinct, or if a dark picture is being projected, the automatic setup processing may stop automatically before it is complete. If this happens, project a different picture and then press the AUTO SETUP button again.

Turning off the picture and sound momentarily (SHUTTER)

The “SHUTTER” function can be used to momentarily turn off the picture and sound from the projector when the projector is not being used for short periods of time, such as during breaks in meetings or when carrying out preparation. The projector uses less power in “SHUTTER” mode than it does in normal projection mode.

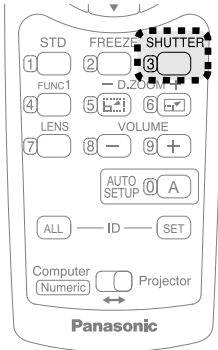

Press the SHUTTER button.

- The picture and sound will be turned off.
- Press any button on either the projector or remote control unit to return to normal operating mode.

Projector control panel

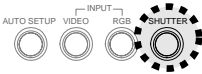

Pausing a picture (FREEZE)

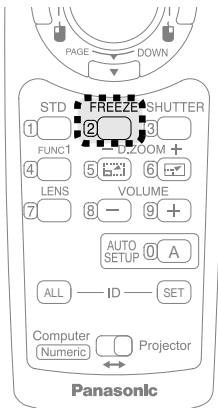

Press the FREEZE button.

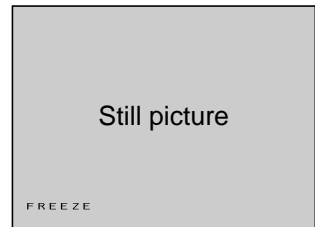

- The picture being projected will be paused.
- Press the FREEZE button again to cancel the still picture.

Enlarging the picture (D.ZOOM)

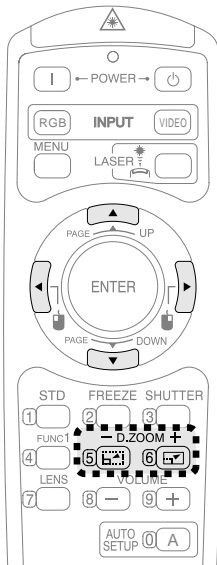

Press the D.ZOOM +/- button.

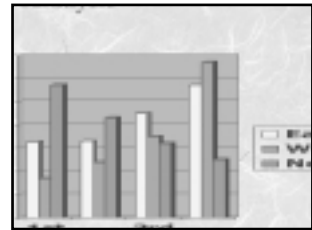
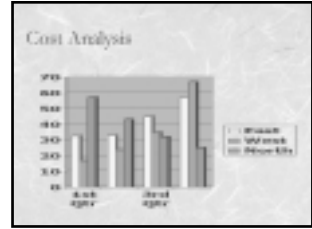

- The picture will then be enlarged to 1.5 times the normal size.

The remote control unit functions during D.ZOOM (digital zoom)

- Press the ▲, ▼, ◀ and ▶ buttons to move the enlarged area which you want to project.
- Press the D.ZOOM +/- buttons to change the enlargement ratio.
- Press the MENU button to return to the normal screen.

NOTE:

- The enlargement ratio can be changed within the range of x1 to x4, in steps of 0.1.
- If the type of signal being input changes while the digital zoom function is being used, the digital zoom function will be cancelled.

Adjusting the volume (VOLUME)

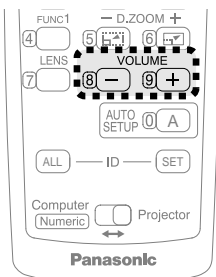

Press the VOLUME +/- button.

- Press the + button to raise the volume.
- Press the - button to lower the volume.

NOTE:

- You can also select "VOLUME" from the "AUDIO" menu to adjust the volume. (page 46)

Adjusting the zoom and focus (LENS)

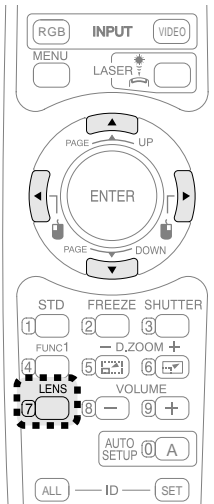

Press the LENS button.



ZOOM FOCUS

- Press the ◀ or ▶ button to adjust the size of the projected image.
- Press the ▲ or ▼ button to adjust the focus of the projected image.

NOTE:

- “ZOOM/FOCUS” in the “LENS” menu is the same function.

Wireless mouse

By connecting the wireless mouse receiver (ET-RMRC2, sold separately) to a personal computer, you can use the remote control unit as a personal computer mouse.

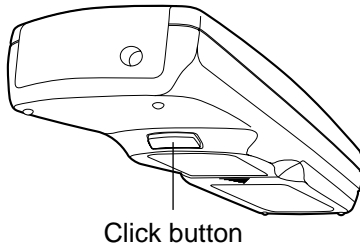
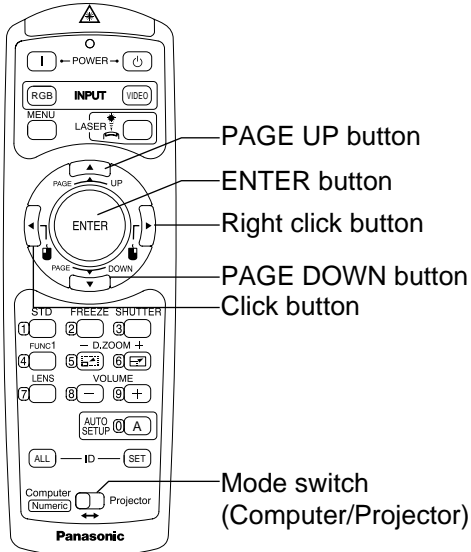

Mode switch (Computer/Projector)

Move the mode switch to the "Computer" position.

- **PAGE UP button**
Functions as the Page Up button on a personal computer keyboard.
- **PAGE DOWN button**
Functions as the Page Down button on a personal computer keyboard.
- **ENTER button**
Pressing the upper, lower, left and right edges of this button can move the cursor up, down, left and right.
- **Right click button**
This button functions as the right button on a personal computer mouse.
- **Click button**
This button functions as the left button on a personal computer mouse.

On-screen menus

Menu screens

The various settings and adjustments for this projector can be carried out by selecting the operations from on-screen menus.

The general arrangement of these menus is shown below.

PICTURE menu (page 39)

When an RGB/DVI signal is being input

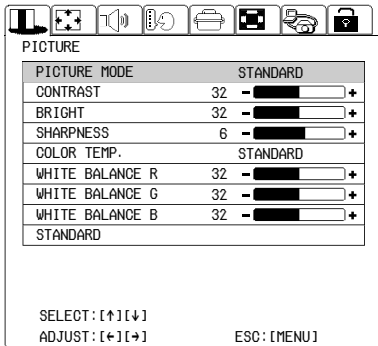

When a YPbPr signal is being input

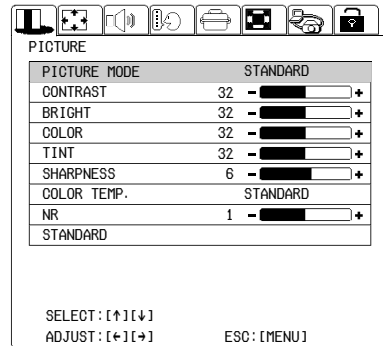

When an S-VIDEO/VIDEO signal is being input

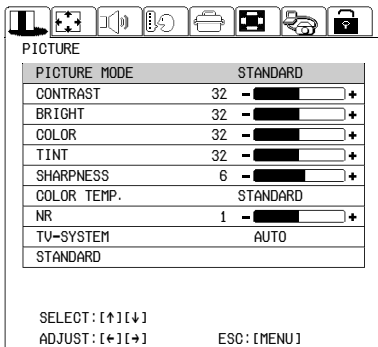

NOTE:

- Keystone distortion of the on-screen display will not be corrected.
- This projector has unadjustable items and unusable functions depending on the signal being input.

When an item cannot be adjusted or a function cannot be used, the corresponding on-screen menu display does not appear, and the item or function will not work even if the ENTER button is pressed.

POSITION menu (page 42)

When an RGB/DVI signal is being input

POSITION		
POSITION	H: 128	V: 32
DOT CLOCK	32	— [Progress Bar]
CLOCK PHASE	16	— [Progress Bar]
KEYSTONE	H: 0	V: 0
OSD POSITION	TOP LEFT	
RESIZING	OFF	ON
AUTO SETUP		
FRAME LOCK	OFF	ON
STANDARD		

SELECT: [↑][↓] ENTER: [ENTER]
ESC: [MENU]

“POSITION”, “DOT CLOCK” and “CLOCK PHASE” are not displayed when a DVI signal is being input.

When an S-VIDEO/VIDEO signal is being input

POSITION		
POSITION	H: 32	V: 16
KEYSTONE	H: 0	V: 0
OSD POSITION	TOP LEFT	
ASPECT	4:3	
RESIZING	OFF	ON
AUTO SETUP		
STANDARD		

SELECT: [↑][↓] ENTER: [ENTER]
ESC: [MENU]

AUDIO menu (page 46)

AUDIO		
VOLUME	20	— [Progress Bar]
MUTE	OFF	ON

SELECT: [↑][↓] ENTER: [ENTER]
ADJUST: [+][−] ESC: [MENU]

When a YPbPr signal is being input

POSITION		
POSITION	H: 64	V: 16
CLOCK PHASE	16	— [Progress Bar]
KEYSTONE	H: 0	V: 0
OSD POSITION	TOP LEFT	
ASPECT	4:3	
RESIZING	OFF	ON
AUTO SETUP		
STANDARD		

SELECT: [↑][↓] ENTER: [ENTER]
ESC: [MENU]

LANGUAGE menu (page 46)

LANGUAGE		
ENGLISH	ESPAÑOL	日本語
DEUTSCH	ITALIANO	中文
FRANÇAIS	РУССКИЙ	한국어

SELECT: [↑][↓] ESC: [MENU]
SELECT: [+][−] ENTER: [ENTER]

OPTION menu (page 47)

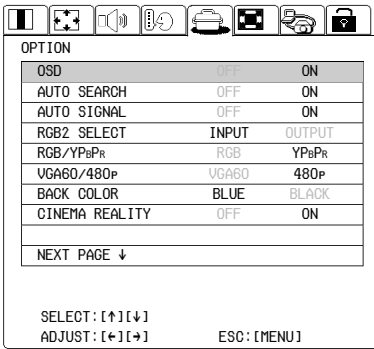

OPTION

OSD	OFF	ON
AUTO SEARCH	OFF	ON
AUTO SIGNAL	OFF	ON
RGB2 SELECT	INPUT	OUTPUT
RGB/YPbPr	RGB	YPbPr
UGA60/480P	UGA60	480P
BACK COLOR	BLUE	BLACK
CINEMA REALITY	OFF	ON
NEXT PAGE ↓		

SELECT: [↑][↓]
ADJUST: [+][→] ESC: [MENU]

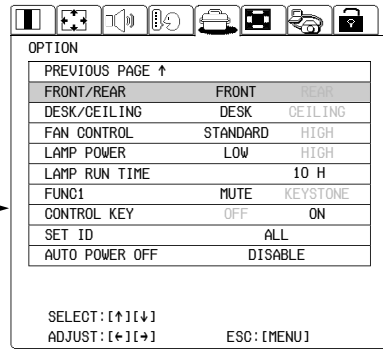

OPTION

PREVIOUS PAGE ↑		
FRONT/REAR	FRONT	REAR
DESK/CEILING	DESK	CEILING
FAN CONTROL	STANDARD	HIGH
LAMP POWER	LOW	HIGH
LAMP RUN TIME	10 H	
FUNC1	MUTE	KEystone
CONTROL KEY	OFF	ON
SET ID	ALL	
AUTO POWER OFF	DISABLE	

SELECT: [↑][↓]
ADJUST: [+][→] ESC: [MENU]

“RGB/YPbPr” is displayed when an RGB/YPbPr signal is being input.

LENS menu (page 50)

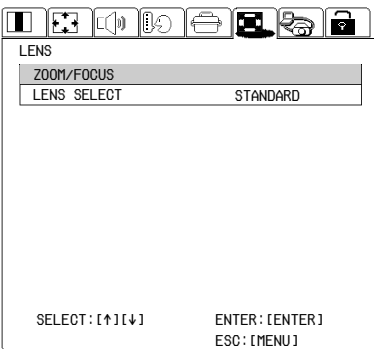

LENS

ZOOM/FOCUS		
LENS SELECT	STANDARD	

SELECT: [↑][↓] ENTER: [ENTER]
ESC: [MENU]

NETWORK menu (page 50)

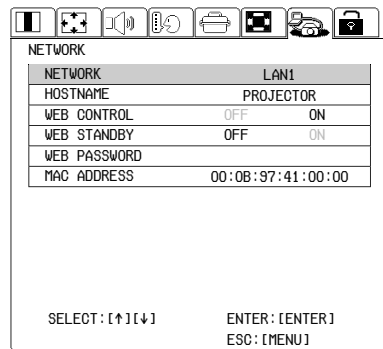

NETWORK

NETWORK	LAN1	
HOSTNAME	PROJECTOR	
WEB CONTROL	OFF	ON
WEB STANDBY	OFF	ON
WEB PASSWORD		
MAC ADDRESS	00:08:97:41:00:00	

SELECT: [↑][↓] ENTER: [ENTER]
ESC: [MENU]

SECURITY menu (page 51)

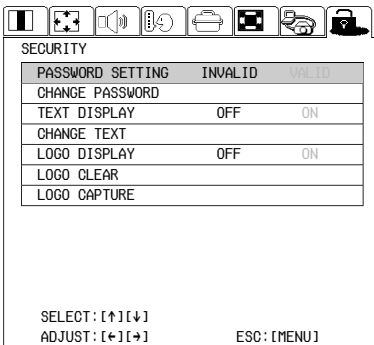

SECURITY

PASSWORD SETTING	INVALID	VALID
CHANGE PASSWORD		
TEXT DISPLAY	OFF	ON
CHANGE TEXT		
LOGO DISPLAY	OFF	ON
LOGO CLEAR		
LOGO CAPTURE		

SELECT: [↑][↓]
ADJUST: [+][→] ESC: [MENU]

Menu operation guide

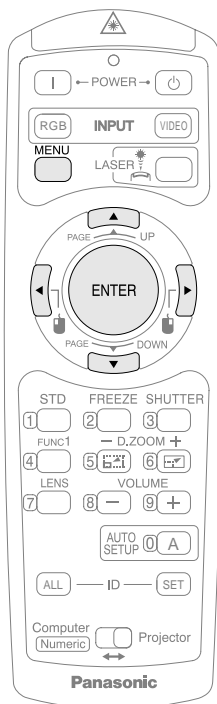

- Press the MENU button.**
 The menu screen will be displayed.

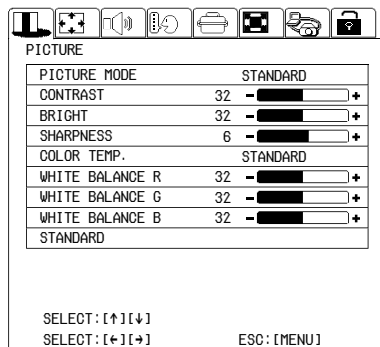

- Press the ◀ or ▶ button to select a menu.**
 The selected menu screen will then be displayed.
 (Example: "POSITION" menu)

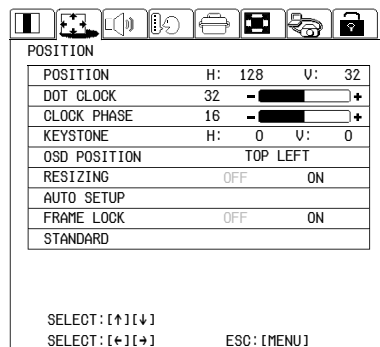

Projector control panel

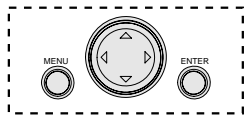

- Press the ▼ button to accept the selection.**
 You can select an item here. The selected item is shown in yellow.

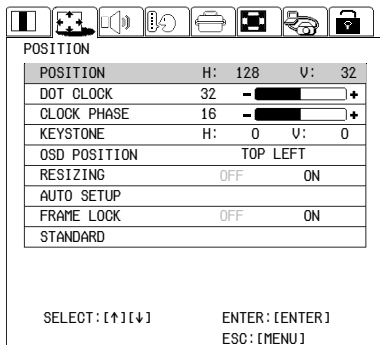

NOTE:

- Press the MENU button to return to the previous screen.

- ④ Press the ▲ or ▼ button to select an item.

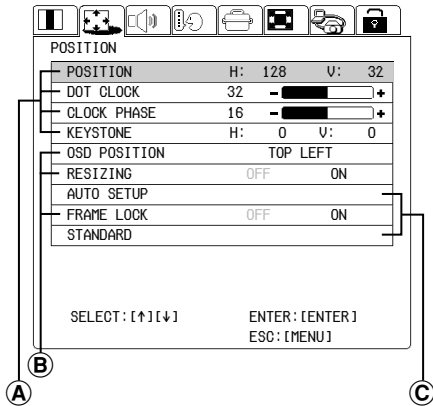

- Ⓐ For the value adjusting items Press the ENTER button to display an individual adjustment screen.

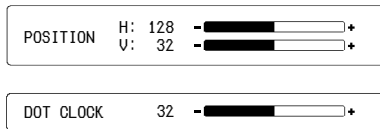

Press the ◀ or ▶ button to adjust the setting.

Some items can be adjusted by pressing the ▲ or ▼ button. You can also adjust the bar-scale items pressing the ◀ or ▶ button in the menu screen.

- Ⓑ For the selective items



Press the ◀ or ▶ button to select the setting.

- Ⓒ For the fixed items

Press the ENTER button, and the function will work.

Returning a setting to the factory default

If you press the STD (standard) button on the remote control unit, you can return settings to the factory default settings. However, the operation of this function varies depending on which screen is being displayed.

- When a menu screen is being displayed

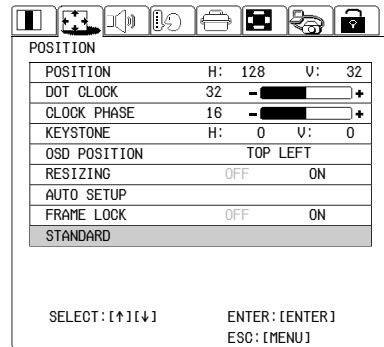

All items displayed will be returned to their factory default settings.

NOTE:

- You can also select “STANDARD” from the menu screen and then press the ENTER button.
- When an individual adjustment screen is being displayed

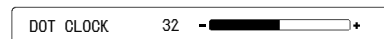

Only the item displayed will be returned to the factory default setting.

Adjusting the picture

Press the ▲ or ▼ button on the projector or remote control unit to select an item, and then press the ◀ or ▶ button to change the setting.

For the value adjusting items, press the ENTER button to display the adjustment screen, and then press the ◀ or ▶ button to make the adjustment.

When an RGB/DVI signal is being input

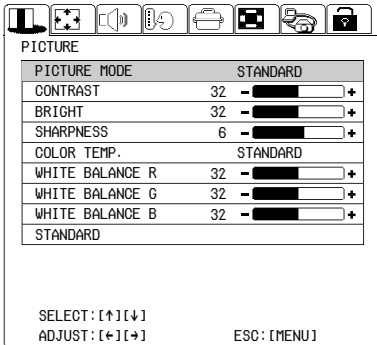

When a YPbPr signal is being input

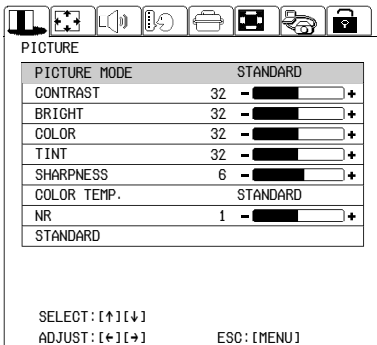

When an S-VIDEO/VIDEO signal is being input

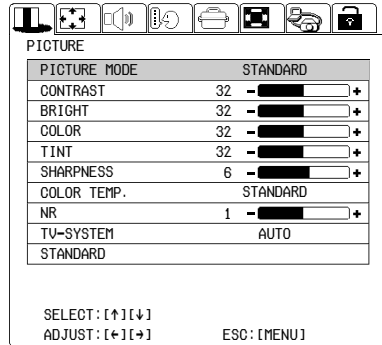

PICTURE MODE

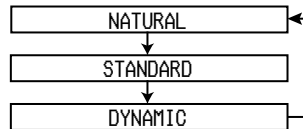

Select the picture mode that best matches the image source and room conditions.

The mode best used in dark rooms is “NATURAL”. For rooms having regular lighting conditions in use, select “STANDARD”. For exceptionally bright rooms, use “DYNAMIC”.

CONTRAST

This adjusts the contrast of the picture. (Adjust the “BRIGHT” setting first if required before adjusting the “CONTRAST” setting.)

The picture is bright: ◀ button

The picture is dark: ▶ button

BRIGHT

This adjusts the darker areas (black areas) in the picture.

Black areas are too light: ◀ button

Dark areas are too solid: ▶ button

COLOR

(S-VIDEO/VIDEO/YPbPr only)

The color is too deep: ◀ button

The color is too pale: ▶ button

TINT

(NTSC/NTSC 4.43/YPbPr only)

This adjusts the flesh tones in the picture.

The flesh tones are greenish:

◀ button

The flesh tones are reddish:

▶ button

SHARPNESS

To soften the picture details:

◀ button

To sharpen the picture details:

▶ button

COLOR TEMP.

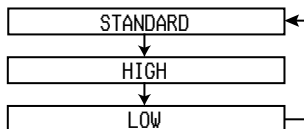

This is used to adjust the white areas of the picture if they appear bluish or reddish.

Noise Reduction (NR)

(S-VIDEO/VIDEO/480i and 576i YPbPr only)

If the signal is of such poor quality that picture interference appears, you can suppress this interference by adjusting the “NR” (Noise Reduction).

To turn off the “NR” feature (set the value to “0”):

◀ button

To strengthen the effect:

▶ button

WHITE BALANCE R/G/B

(RGB only)

This is used to adjust the white areas of the picture if they appear colorised.

To make the selected color lighter:

◀ button

To make the selected color stronger:

▶ button

TV-SYSTEM

(S-VIDEO/VIDEO only)

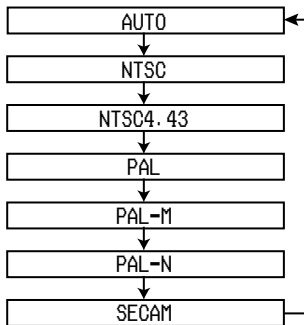

This should normally be set to “AUTO”. If the signal is of such poor quality that the correct format cannot be automatically distinguished, change the setting manually to the required TV system.

NOTE:

- When set to “AUTO”, the projector automatically distinguishes between NTSC/NTSC 4.43/PAL/PAL60/PAL-M/PAL-N/SECAM signals.

Projecting sRGB-compatible pictures

sRGB is an international color reproduction standard (IEC61966-2-1) established by the International Electrotechnical Commission (IEC). If you would like the colors in sRGB-compatible pictures to be reproduced more faithfully, make the following settings.

- ① Press the ▲ or ▼ button to select “PICTURE MODE”, and then press the ◀ or ▶ button to select “NATURAL”.
- ② Press the ▲ or ▼ button to select “COLOR TEMP.”, and then press the ◀ or ▶ button to select “STANDARD”.
- ③ Press the STD (standard) button on the remote control unit.
- ④ Press the ▲ or ▼ button to select “LAMP POWER” in the “OPTION” menu, and then press the ◀ or ▶ button to select “HIGH”.

NOTE:

- sRGB is only enabled when RGB signals are being input.

Adjusting the position

When an RGB signal is being input, press the AUTO SETUP button first to initiate automatic positioning. If the optimum setting is not obtained when “AUTO SETUP” is carried out, adjust by the following procedure.

Press the ▲ or ▼ button on the projector or remote control unit to select an item, and then press the ◀ or ▶ button to change the setting. For the value adjusting items, press the ENTER button to display the adjustment screen, and then press the ◀ or ▶ button to make the adjustment. Some items can be adjusted pressing the ▲ or ▼ button.

When an RGB/DVI signal is being input



POSITION

POSITION	H: 128	U: 32
DOT CLOCK	32	+
CLOCK PHASE	16	+
KEYSTONE	H: 0	V: 0
OSD POSITION	TOP LEFT	
RESIZING	OFF	ON
AUTO SETUP		
FRAME LOCK	OFF	ON
STANDARD		

SELECT: [↑] [↓] ENTER: [ENTER]
ESC: [MENU]

“POSITION”, “DOT CLOCK” and “CLOCK PHASE” are not displayed when a DVI signal is being input.

When a YPbPr signal is being input



POSITION

POSITION	H: 64	U: 16
CLOCK PHASE	16	+
KEYSTONE	H: 0	V: 0
OSD POSITION	TOP LEFT	
ASPECT	4:3	
RESIZING	OFF	ON
AUTO SETUP		
STANDARD		

SELECT: [↑] [↓] ENTER: [ENTER]
ESC: [MENU]

When an S-VIDEO/VIDEO signal is being input



POSITION

POSITION	H: 32	U: 16
KEYSTONE	H: 0	V: 0
OSD POSITION	TOP LEFT	
ASPECT	4:3	
RESIZING	OFF	ON
AUTO SETUP		
STANDARD		

SELECT: [↑] [↓] ENTER: [ENTER]
ESC: [MENU]

POSITION

Moves the picture position.

Press the ◀ or ▶ button to move the picture horizontally.

Press the ▲ or ▼ button to move the picture vertically.

POSITION	H: 128	+
	V: 32	+

DOT CLOCK

(RGB only)

Periodic striped pattern interference (noise) may occur when a striped pattern such as the one below is projected. If this happens, press the ◀ or ▶ button to adjust so that any such noise is minimised.

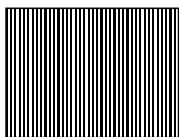

CLOCK PHASE

(RGB/YPbPr only)

Adjust the “DOT CLOCK” setting first before carrying out this adjustment. Press the ◀ or ▶ button to adjust so that the noise level is least noticeable.

NOTE:

- If signals with a dot clock frequency of 108 MHz or higher are being input, interference may not be completely eliminated when the “DOT CLOCK” and “CLOCK PHASE” adjustments are carried out.

KEYSTONE

If the projected image contains keystone distortion, follow the procedures in the table to correct any keystone distortion.

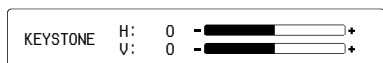

Picture condition	Operation
	Press the ▲ button.
	Press the ▼ button.
	Press the ◀ button.
	Press the ▶ button.

NOTE:

- The greater the correction of keystone distortion amount, the more the picture quality will deteriorate, and the harder it will become to achieve a good level of focus. To obtain the best picture quality, set up the projector and screen in such a way that the amount of keystone correction required is as minimal as possible.
- The picture size will also change when correction of keystone distortion is carried out.
- The range of keystone correction varies depending on the type of signal being input (including when no signal is being input). If you make an adjustment that is outside the allowable range, the setting will not be changed. In addition, if the input signal is changed after keystone correction has been carried out, the correction setting may be cancelled. This indicates

that the current correction setting exceeds the allowable range for the new input signal.

- If you correct both vertical and horizontal keystone distortion at the same time, the allowable range of keystone correction becomes smaller. If you make an adjustment that is outside the allowable range, the setting will not be changed.
- The ratio of length and width of an image may become incorrect depending on the amount of the keystone correction.

OSD POSITION

Press the ◀ or ▶ button to move the OSD position.

ASPECT

(S-VIDEO/VIDEO/480i, 576i, 480p and 576p YPbPr only)

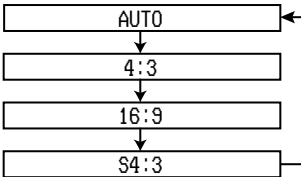

AUTO

(S-VIDEO only)

When an S1 video signal is being input, the aspect ratio is changed automatically to project a 16:9 picture.

4:3

The input signal is projected without change.

16:9

The picture is compressed to a ratio of 16:9 and projected.

When a horizontally squeezed signal is being input.

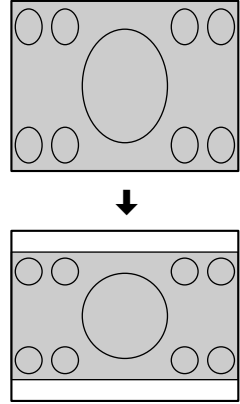

S4:3

The size of the input signal is compressed to 75% and projected. (This is useful for projecting a picture with a 4:3 aspect ratio onto a 16:9 screen.)

When a 4:3 signal is being input.

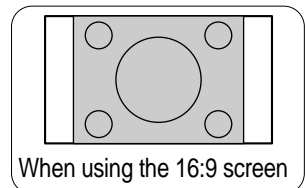
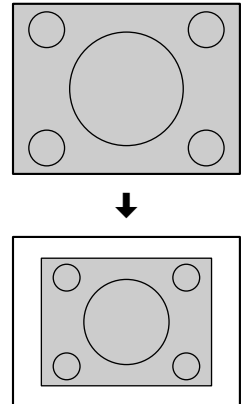

S1 video signals

- S1 video signals are a type of video signal with an aspect ratio of 16:9 which include a detector signal. This detector signal is output by some sources such as wide-vision video decks.
- When “ASPECT” is set to “AUTO”, the projector recognizes the detector signal and automatically switches the aspect ratio to 16:9.

NOTE:

- If a selected mode does not match the aspect ratio of the input signal, it may affect the quality of viewing of the original picture. Keep this in mind when selecting the aspect ratio.
- If using this projector in places such as cafes or hotels to display programs for a commercial purpose or for public presentation, note that if the aspect ratio (16:9) selection function is used to change the aspect ratio of the screen picture, you may be infringing the rights of the original copyright owner for that program under copyright protection laws.
- If a normal (4:3) picture which was not originally intended for wide-screen viewing is projected onto a wide screen, distortion may occur around the edges of the picture, or part of the picture may not be visible. Such programs should be viewed in 4:3 mode to give proper consideration to the aims and intentions of the original programme’s creator.

RESIZING

This should normally be set to “ON”. (This setting is only for signals which have lower resolutions than the LCD panels. Refer to page 70 for details.)

ON

The pixel resolution of the input signal is converted to the same resolution as the LCD panels before being projected. For signals with lower resolutions, gaps in the pixels are automatically interpolated into the picture before it is projected. This may sometimes cause problems with the quality of the picture.

OFF

The input signal is projected at its original resolution, with no pixel conversion. The projected picture will be smaller than normal, so adjust the zoom setting or move the projector forwards or backwards to adjust the picture size if necessary. If set to “OFF”, some features, such as “D.ZOOM” (digital zoom) or “KEYSTONE” will not function.

AUTO SETUP

This item functions in the same way as the AUTO SETUP button on the remote control unit and the projector control panel. (page 28)

FRAME LOCK

If the picture’s condition is bad while a RGB moving picture is projected, set “FRAME LOCK” to “ON”. Refer to page 70 for compatible RGB signals.

Audio adjustment

Press the ▲ or ▼ button on the projector or remote control unit to select an item.

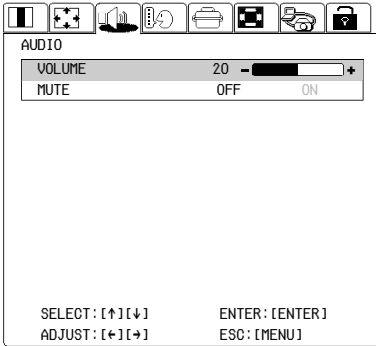

VOLUME

Press the ◀ or ▶ button to adjust the volume of the sound output.

MUTE

Set to "ON" pressing the ◀ or ▶ button to turn off the volume of the sound output. To cancel muting, set to "OFF".

Changing the display language

Press the ▲, ▼, ◀ and ▶ buttons on the projector or remote control unit to select a language, then press the ENTER button to accept the setting.



Option settings

Press the ▲ or ▼ button on the projector or remote control unit to select an item, then press the ◀ or ▶ button to change the setting.

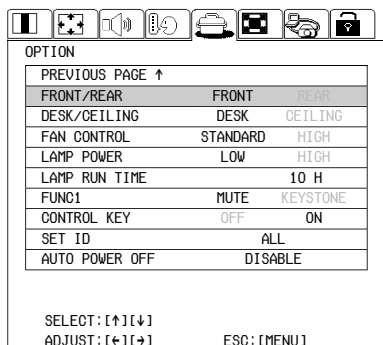
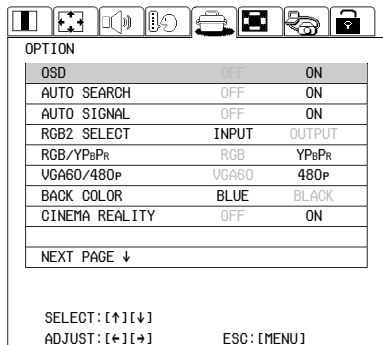

OSD

ON

The signal name is displayed in the top-right corner of the screen when the input signal is changed.

OFF

Use this setting when you do not want the signal name to be displayed.

NOTE:

- The setting for “TV-SYSTEM” will also be displayed when an S-VIDEO/VIDEO signal is being input.

AUTO SEARCH

ON

The input signal will be detected and selected automatically when the input select (RGB, VIDEO) buttons are pressed for a few seconds. (page 14)

OFF

“AUTO SEARCH” is disabled.

NOTE:

- “AUTO SEARCH” will not function when the input signal is being projected.

AUTO SIGNAL

This should normally be set to “ON”.

ON

“AUTO SETUP” will be carried out automatically when the input signal is changed.

OFF

“AUTO SETUP” will not function when the input signal is changed.

RGB2 SELECT

This setting is used to select the function of the RGB2 IN/RGB OUT connector.

When set to “OUTPUT”, the selected input signal (RGB1 or RGB3) will be output.

RGB/YPbPr

This setting is valid when 480i, 576i, 480p, 576p, 1 080/60i, 1 080/50i and 720/60p signals are being input. Select the setting in accordance with the input signal.

“RGB/YPbPr” is displayed when the RGB1 IN, RGB2 IN or RGB3 IN connector has a signal being input.

VGA60/480p

Set to “VGA60” when 59.9Hz VGA480 signals are being input (refer to page 70 for details). Set to “480p” when 480p RGB signals are being input.

BACK COLOR

This sets the color which is projected onto the screen when no signal is being input to the projector.

CINEMA REALITY

(S-VIDEO/VIDEO/480i and 576i YPbPr only)

ON

Set to “ON” when you would like 24 frames per second pictures (such as movies) to project the source faithfully.

OFF

Set to “OFF” when the projected pictures have problems with captions or subtitles when the setting is “ON”.

FRONT/REAR

This setting should be changed in accordance with the projector setting-up method. (Refer to page 18.)

FRONT

When the projector is placed in front of a screen.

REAR

When using a translucent screen.

DESK/CEILING

This setting should be changed in accordance with the projector setting-up method. (Refer to page 18.)

DESK

When the projector is placed on a desk or similar.

CEILING

When the projector is suspended from a ceiling using the ceiling bracket (sold separately).

FAN CONTROL

Set “FAN CONTROL” to “HIGH”, when using this projector at high elevations (above 1 400 m) only.

LAMP POWER

This setting changes the lamp brightness. When set to “LOW”, the luminance of the lamp is reduced, but the projector uses less power, and the operating noise is also reduced. This can help to extend the lamp’s operating life. If using the projector in small rooms where high luminance is not required, it is recommended that you set the “LAMP POWER” to “LOW”.

LAMP RUN TIME

This setting displays the usage time for the lamp unit which is currently being used. When replacing the lamp unit, follow the instructions on page 58, and reset “LAMP RUN TIME” to “0”.

NOTE:

- The lamp’s operating life varies depending on the usage conditions (such as the “LAMP POWER” setting and the number of times the power is turned on and off).

FUNC 1

This assigns a function to the FUNC1 button of the remote control unit .

MUTE

Functions in the same way as the “MUTE” function. (page 46)

KEYSTONE

Functions in the same way as when “KEYSTONE” is selected from the “POSITION” menu screen. (page 43)

CONTROL KEY

To disable the buttons on the projector, set “CONTROL KEY” to “OFF”. A confirmation screen will then be displayed. Select “OK” by pressing the ◀ or ▶ button. To use the buttons on the projector, set to “ON” by using the remote control unit.

AUTO POWER OFF

If no signal is input to the projector for the duration of the period you set, the projector will return to standby mode. The period can be set from 15 minutes to 60 minutes in 5 minute intervals. If you don't use this feature, set it to “DISABLE”. This feature will not function when using the “FREEZE” function.

NOTE:

- When the projector is connected to a personal computer via a wired LAN, the projector will go into “WEB STANDBY” mode. (page 50)

SET ID

This item is used to set the projector ID number to control two or more projectors either simultaneously or separately.

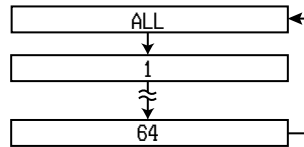

ALL

The projectors can be controlled from any remote control unit regardless of their ID numbers.

1-64

The projector can be controlled from the remote control unit with the same ID number.

NOTE:

- “SET ID” is set to “ALL” by default. Hence ID number need not be set when only one projector is used.
- If the projectors are given ID numbers, their remote control units must be assigned the same ID numbers, respectively.
- When several projectors are set up together and “SET ID” is set to “ALL”, none of the projectors can be operated separately from other projectors, even if they have been set with different ID numbers.
- The projector cannot be turned on and off from the remote control unit if the “CONTROLLER ID” does not match the projector ID number. For details on setting the projector ID number in the remote control unit, refer to page 23.

Adjusting the lens

Press the ▲ or ▼ button on the projector or remote control unit to select an item. When adjusting “ZOOM/FOCUS”, press the ENTER button to display the adjustment screen.

Press the LENS button.

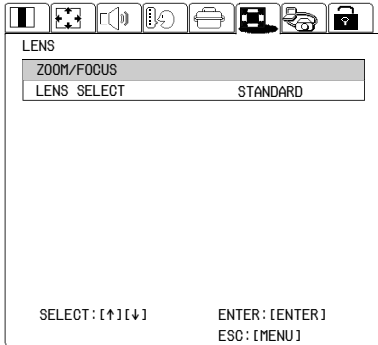

Network setup

You need adjust some items when controlling the projector with a personal computer via a wired LAN. Refer to the “Network Function Edition” operating instructions for details.

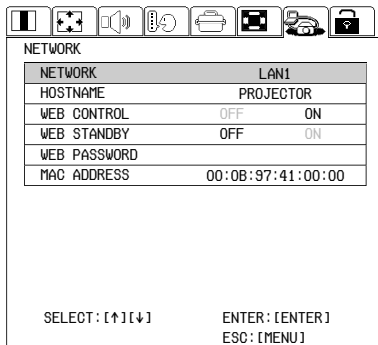

NETWORK

Network settings can be selected and you can then make further settings.

HOSTNAME

The host name for this projector can be set.

ZOOM/FOCUS

Refer to page 31 for details.

LENS SELECT

Change the setting in accordance with the type of projection lens (sold separately) by pressing the ◀ or ▶ button.

STANDARD

For standard projection

LONG FOCUS

For ET-LE30

MIDDLE FOCUS

For ET-LE20

SHORT FOCUS

For ET-LE10

WEB CONTROL

To control the projector with a personal computer via a wired LAN, set “WEB CONTROL” to “ON”. To prevent it, set to “OFF”.

WEB STANDBY

To turn on the power with a personal computer via a wired LAN, set the “WEB STANDBY” to “ON”. When the projector is in “WEB STANDBY” mode (the projector is in standby mode and connected to a computer via a wired LAN), the cooling fan operates and the power indicator on the projector flashes slowly in red.

WEB PASSWORD

You can set the password for controlling the projector with a personal computer via a wired LAN.

MAC ADDRESS

Displays the MAC address (Media Access Control Address), which is unique to the network device. This function may be needed when using the DHCP server.

Setting up the security function

This projector is equipped with a security function. A password input screen can be displayed, or a company URL can be set up and displayed at the bottom of the projected image. A logo also can be displayed before projection.

Press the ◀ or ▶ button on the projector or remote control unit to select “SECURITY”, then press the ▼ button.

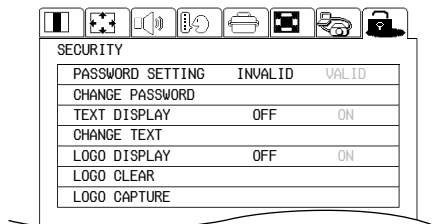

PASSWORD

OK : [ENTER] CANCEL : [MENU]

(When you use the “SECURITY” function for the first time)

Press the ▲, ▶, ▼, ◀, ▲, ▶, ▼ and ◀ buttons in order, then press the ENTER button.

(When a password change has been made before)

Type in the changed password, then press the ENTER button.

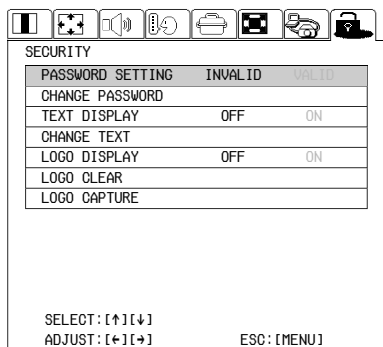

PASSWORD SETTING

The password input screen can be displayed when the power is turned on. All of the controls other than the POWER button are disabled unless the password is entered correctly.

VALID

“PASSWORD SETTING” is enabled.

INVALID

“PASSWORD SETTING” is disabled. The password input screen will not be displayed when the power is turned on.

CHANGE PASSWORD

Passwords can be changed. Press the ENTER button to display the “CHANGE PASSWORD” screen.

NEW

CONFIRM

FINISH : [ENTER] CANCEL : [MENU]

- ① Set a password by pressing the ▲, ▼, ◀, and ▶ buttons. (A maximum of 8 buttons can be set.)
- ② Press the ENTER button.
- ③ Enter the password again for confirmation.
- ④ Press the ENTER button. Password change will be completed.

NOTE:

- The entered password will appear as *. It will not be displayed on the screen.
- If you enter the wrong password, the letters "PASSWORD" and "NEW" will become red. Enter the correct password again.

TEXT DISPLAY

You can set text to be displayed at the bottom of the projected image at all times.

ON

"TEXT DISPLAY" is enabled.

OFF

"TEXT DISPLAY" is disabled.

CHANGE TEXT

The text which is displayed when "TEXT DISPLAY" is set to "ON" can be changed.

Press the ENTER button to display the "CHANGE TEXT" screen.

Above: Setting before change

Below: Setting after change

Cursor

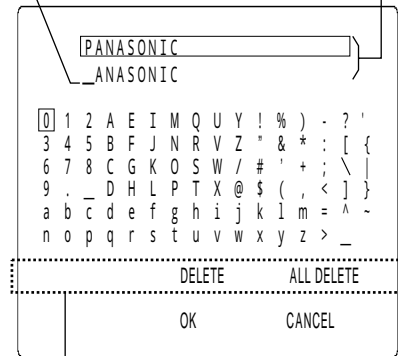

Editing items

- ① Press the ▲, ▼, ◀ and ▶ buttons to select the letters, then press the ENTER button. (You can enter 20 letters continuously.)

<Editing Items>

←

Moves cursor to left.

→

Moves cursor to right.

DELETE

Deletes a letter on the cursor.

ALL DELETE

Deletes all the letters.

- ② Press the ▲, ▼, ◀ and ▶ buttons to select "OK", then press the ENTER button.
 - Select "CANCEL" to cancel the change.

NOTE:

- The letters which cannot be input will be displayed in gray, and cannot be selected in “CHANGE TEXT”.

LOGO DISPLAY

A logo can be displayed before projection.

ON

“LOGO DISPLAY” is enabled.

OFF

“LOGO DISPLAY” is disabled.

LOGO CLEAR

Captured logo data can be cleared. Press the ENTER button to display the confirmation screen, and then select “OK”.

LOGO CAPTURE

A logo can be captured from the picture being projected. Press the ENTER button to display the capture adjustment screen.

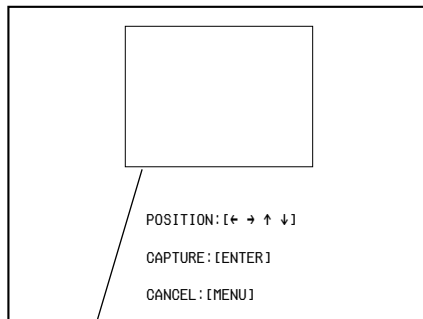

Capturing frame

- ① Press the ▲ ▼ ◀ and ▶ buttons to move the capturing frame to the area you want to capture.
- ② Press the ENTER button.
 - The letters “CAPTURE ...” and the progress status will be displayed while logo capture is being carried out.

NOTE:

- The size of the capturing frame varies depending on the signals being input.
- Fine images such as landscapes may be unable to be captured.
- Only RGB signals can be captured. (Except 480i, 576i, 480p, 576p, 1 080/60i, 1 080/50i and 720/60p. Refer to page 70 for details.)
- Images with 512 x 384 pixels can be captured.
- It is recommended that you input XGA signals, and set “KEYSTONE” to “0” when carrying out “LOGO CAPTURE”.

When the TEMP indicator and the LAMP indicator are illuminated

There are two indicators on the control panel of the projector which give information about the operating condition of the projector. These indicators illuminate or flash to warn you about problems that have occurred inside the projector, so if you notice that one of the indicators is on, turn off the power and check the table below for the cause of the problem.

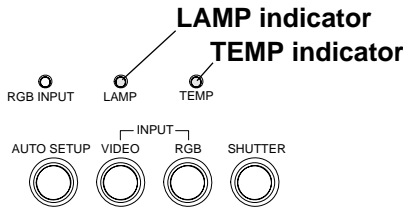

TEMP indicator		
Indicator display	Illuminated (red) (Lamp unit on)	Flashing (red) (Lamp unit off)
Problem	The surrounding temperature or the temperature inside the projector has become unusually high.	The surrounding temperature or the temperature inside the projector has become dangerously high, causing the lamp unit to automatically shut off.
Possible cause	<ul style="list-style-type: none"> ● The ventilation holes may be covered. ● The ambient temperature in the place of use may be too high. ● The air filter may be blocked. 	
Remedy	<ul style="list-style-type: none"> ● Uncover the ventilation holes. ● Set up the projector in a place where the temperature is between 0 °C (32 °F) and 40 °C (104 °F) and the humidity is between 20% and 80% (with no condensation). [If you set the "FAN CONTROL" to "HIGH" (page 48), set up the projector in a place where the temperature is between 0 °C (32 °F) and 35 °C (95 °F) and the humidity is between 20% and 80% (with no condensation).] ● Turn off the MAIN POWER switch by following the procedure on page 26, and then clean the air filter (refer to page 56). 	

LAMP indicator			
Indicator display	lluminated (red)	Flashing (red)	
Problem	It is nearly time to replace the lamp unit.	An abnormality has been detected in the lamp circuit.	
Possible cause	<ul style="list-style-type: none"> Does “REPLACE LAMP” appear on the screen after the projector is turned on? 	<ul style="list-style-type: none"> The power may have been turned on straight away after it was turned off. 	<ul style="list-style-type: none"> There may be an abnormality in the lamp circuit.
Remedy	<ul style="list-style-type: none"> This occurs when the operation time for the lamp unit is nearing 1 350 hours (when “LAMP POWER” has been set to “HIGH”). Ask your dealer or an Authorized Service Center to replace the lamp unit. 	<ul style="list-style-type: none"> Wait for a while until the lamp unit cools down before turning the power back on again. 	<ul style="list-style-type: none"> Turn off the MAIN POWER switch by following the procedure given on page 26, and then contact an Authorized Service Center.

NOTE:

- Be sure to turn off the MAIN POWER switch by following the procedure given in “Turning off the power” on page 26 before carrying out any of the procedures in the “Remedy” column.
- If the power turns off after the TEMP indicator has illuminated, it means an abnormality has occurred. Please contact an Authorized Service Center so that the necessary repairs can be made.

Cleaning and replacing the air filter

If the air filter becomes clogged with dust, the internal temperature of the projector will rise, the TEMP indicator will illuminate and the projector's power will turn off (the TEMP indicator will flash after the power is turned off). **The air filter should be cleaned every 100 hours of use.**

- ① **Turn off the MAIN POWER switch and disconnect the power cord plug from the wall outlet.**

Turn off the MAIN POWER switch according to the procedure given in "Turning off the power" on page 26 before disconnecting the power cord plug from the wall outlet.

- ② **Gently turn the projector upside down.**

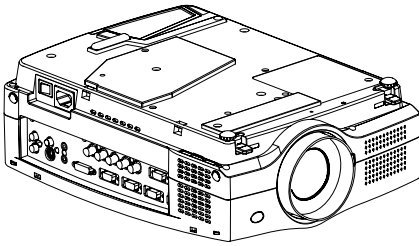

NOTE:

- Place the projector on top of a soft cloth so that it will not become scratched.

- ③ **Remove the air filter.**

Put your fingernails under the air filter and pull the air filter out of the projector.

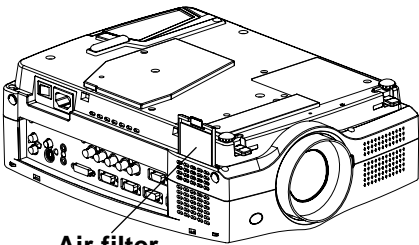

- ④ **Clean the air filter.**

Soak the air filter in water and wash out dirt by hand.

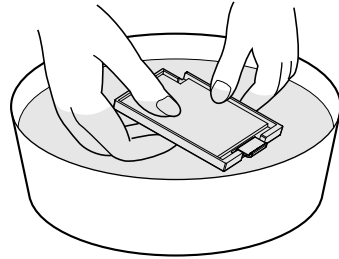

NOTE:

- Do not use detergent.
- Be careful not to separate the air filter cover from the frame when washing the air filter.

- ⑤ **Dry the air filter and install it to the projector.**

NOTE:

- Be sure to install the air filter before using the projector. If the projector is used without the air filter installed, dust and other foreign particles will be drawn into the projector, and malfunctions will result.
- If the dust cannot be removed by cleaning, it is time to replace the air filter. Please consult your dealer. Furthermore, if the lamp unit is being replaced, replace the air filter at this time also.

Replacing the lamp unit

Warning

The lamp unit should only be replaced by a qualified technician.

When replacing the lamp, allow it to cool for at least one hour before handling it.

- The lamp cover gets very hot, and contact with it can cause burns.

Notes on replacing the lamp unit

- The light generating lamp is made of glass, so dropping it or allowing it to hit hard objects may cause it to burst. Be careful when handling the lamp.
- Dispose of the removed old lamp with the same care that would be taken with a fluorescent light.
- A Phillips screwdriver is necessary for removing the lamp unit.

NOTE:

- The projector is not supplied with a replacement lamp unit. Please ask your dealer for details. Lamp unit product no.: **ET-LA785**

CAUTION:

- Do not use any lamp unit other than the one with the product number indicated above.



Lamp unit replacement period

The lamp is a consumable product. Even when the full life of the bulb has not been exhausted, the brightness of the light will gradually decline. Therefore periodic replacement of the lamp is necessary.

The intended lamp replacement interval is 1 500 hours, but it is possible that the lamp may need to be replaced earlier due to variables such as a particular lamp's characteristics, usage conditions and the installation environment. Early preparation for lamp replacement is encouraged. The lamp will automatically shut off after approximately 10 minutes when 1 500 hours of use have been reached because of a much greater chance of it exploding after this time.

NOTE:

- The usage hours explained above are for when "LAMP POWER" in the "OPTION" menu has been set to "HIGH". If "LAMP POWER" is set to "LOW", the brightness of the lamp will be less and life of the lamp can be extended.
- While 1 500 hours is the intended replacement interval, it is not a period of time covered by warranty.

	<p>On-screen display</p> 	<p>LAMP indicator</p> 
<p>More than 1 350 hours</p>	<p>Displayed for 30 seconds. Pressing any button will clear the display.</p>	<p>Illuminates red during image projection and standby mode.</p>
<p>More than 1 500 hours</p>	<p>Remains displayed until any button is pressed.</p>	

Lamp unit replacement procedure

NOTE:

- If the lamp usage time has passed 1 500 hours (when “LAMP POWER” has been set to “HIGH”), the projector will switch to standby mode after approximately 10 minutes of operation. The steps ⑦ to ⑫ on the next page should thus be completed within 10 minutes.

- ① Turn off the **MAIN POWER** switch according to the procedure given in “Turning off the power” on page 26, and then disconnect the power cord plug from the wall outlet and check that the area around the lamp unit has cooled down.

- ② Use a Phillips screwdriver to turn the air outlet port fixing screws at the back of the projector, and then open the air outlet port.

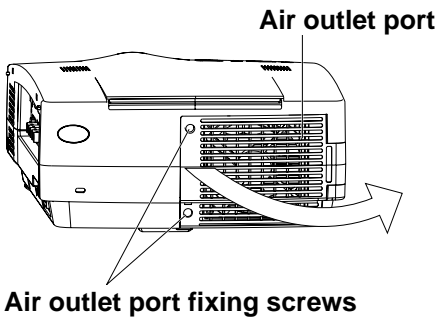

- ③ Use a Phillips screwdriver to loosen the two lamp unit fixing screws until the screws turn freely. Then hold the handle of the lamp unit and gently pull it out from the projector.

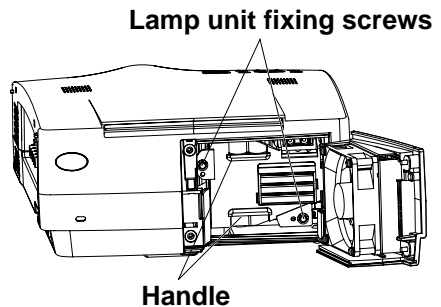

- ④ Insert the new lamp unit while making sure that the direction of insertion is correct, and then use a Phillips screwdriver to securely tighten the lamp unit fixing screws.

- ⑤ Close the air outlet port, and then use a Phillips screwdriver to securely tighten the air outlet port fixing screws.

NOTE:

- Be sure to install the lamp unit and the air outlet port securely. If they are not securely installed, it may cause the protection circuit to operate so that the power cannot be turned on.

- ⑥ Insert the power cord plug into the wall outlet and then press the MAIN POWER switch.

NOTE:

- If the power indicator on the projector does not illuminate red when the MAIN POWER switch is turned on, turn the MAIN POWER switch off again and check that the lamp unit and the air outlet port are securely installed. Then turn the MAIN POWER switch back on.

- ⑦ Press the POWER button so that a picture is projected onto the screen.
- ⑧ Press the MENU button to display the menu screen, and select “OPTION” by pressing the ◀ or ▶ button.

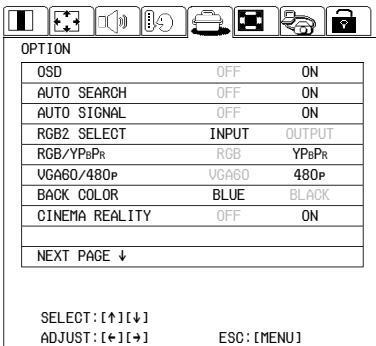

- ⑨ Press the ▼ button and select the “LAMP RUN TIME” by pressing the ▲ or ▼ button.

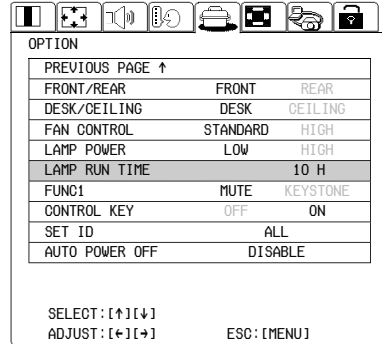

- ⑩ Press and hold the ENTER button for approximately 3 seconds.

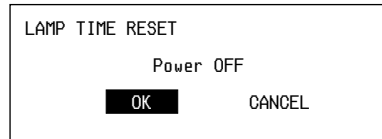

The “LAMP TIME RESET” will be displayed.

- ⑪ Select “OK” by pressing the ◀ or ▶ button and press the ENTER button.

This will reset the cumulative usage time for the lamp unit to zero. The lamp unit will automatically shut off, and the projector will go in the standby mode.

NOTE:

- If “CANCEL” is selected in step ⑪, the operation for resetting the lamp time will be cancelled.

Before calling for service

Before calling for service, check the following points.

Problem	Possible cause	Page
Power does not turn on.	● The power cord may not be connected.	–
	● The MAIN POWER switch is turned off.	–
	● The main power supply is not being supplied to the wall outlet.	–
	● TEMP indicator is illuminated or flashing.	54
	● LAMP indicator is illuminated or flashing.	55
	● The air outlet port has not been securely installed.	59
No picture appears.	● The video signal input source may not be connected properly.	–
	● The input selection setting may not be correct.	25
	● The “BRIGHT” adjustment setting may be at the minimum possible setting.	40
	● The “SHUTTER” function may be in use.	29
The picture is fuzzy.	● The lens cover may still be attached to the lens.	–
	● The lens focus may not have been set correctly.	25, 31
	● The projector may not be at the correct distance from the screen.	19
	● The lens may be dirty.	–
	● The projector may be tilted too much.	19
The color is pale or grayish.	● “COLOR” or “TINT” adjustment may be incorrect.	40
	● The input source which is connected to the projector may not be adjusted correctly.	–
No sound can be heard.	● The audio signal source may not be connected properly.	–
	● The volume adjustment may be at the lowest possible setting.	30, 46
	● A cable may be connected to the AUDIO OUT connector.	20, 21
	● The MUTE function may be active.	46
The remote control unit does not operate.	● The batteries may be weak.	–
	● The batteries may not be inserted correctly.	22
	● The remote control signal receptor on the projector may be obstructed.	22
	● The remote control unit may be out of the operation range.	22

Problem	Possible cause	Page
The buttons on the projector do not function.	<ul style="list-style-type: none"> ● The “CONTROL KEY” may be set to “OFF”. In order to set the “CONTROL KEY” to “ON” without using the remote control unit, keep holding down the ENTER button on the projector and press the MENU button for more than 2 seconds. 	49
The picture does not display correctly.	<ul style="list-style-type: none"> ● The signal format (“TV-SYSTEM”) may not be set correctly. ● There may be a problem with the video tape or other signal source. ● A signal which is not compatible with the projector may be being input. 	41 – 70
Picture from computer does not appear.	<ul style="list-style-type: none"> ● The cable may be too long. ● The external video output for the laptop computer may not be set correctly. (You may be able to change the external output settings by pressing the [Fn]+[F3] or [Fn]+[F10] keys simultaneously. The actual method varies depending on the type of computer, so refer to the documentation provided with your computer for further details.) ● If an RGB INPUT indicator is turned off, the video signals may not be output from the computer. ● “RGB2 SELECT” in the “OPTION” menu is set to “OUTPUT” when the signals are input to RGB2 IN / RGB OUT connector. 	– – 14, 27 47

Cleaning and maintenance

Before carrying out cleaning and maintenance, be sure to disconnect the power cord plug from the wall outlet.

Wipe the cabinet with a soft, dry cloth.

If the cabinet is particularly dirty, soak the cloth in water with a small amount of neutral detergent in it, squeeze the cloth very well, and then wipe the cabinet. After cleaning, wipe the cabinet dry with a dry cloth. If using a chemically-treated cloth, read the instructions supplied with the cloth before use.

Do not wipe the lens with a cloth that is dusty or which produces lint.

If any dust or lint gets onto the lens, such dust or lint will be magnified and projected onto the screen. Use a blower to clean any dust and lint from the lens surface, or use a soft cloth to wipe off any dust or lint.

Using the cable cover

Putting the power cord and remote control unit away

Installing the cable cover

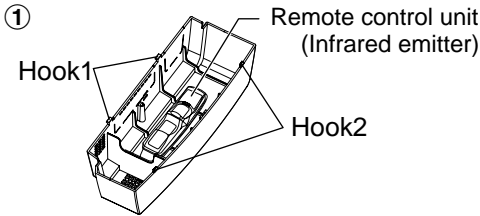

① Put the remote control unit into the cable cover with the buttons facing downward to prevent them from being pressed.

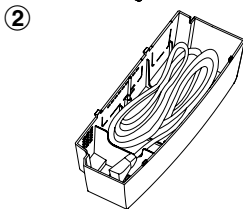

② Put the power cord and other cables into the cable cover.

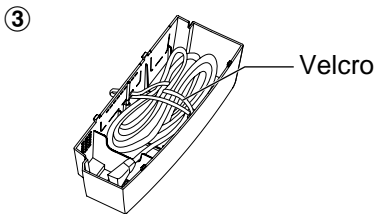

③ Put the Velcro through the hole, and tape it to prevent the cables from dropping out.

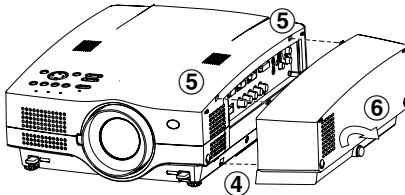

④ Insert the hook 1 of the cable cover into the mounting holes in the projector.

⑤ Push in the hook 2 until it locks into place.

⑥ Tighten the screw by turning it clockwise.

Removing the cable cover

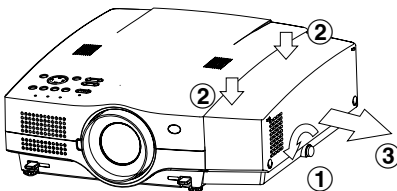

① Loosen the screw by turning it anticlockwise.

② Release the two hooks at the top of the cable cover.

③ Pull the cable cover to the rear to remove it from the projector.

NOTE:

Do not lift up the projector by holding the cable cover, otherwise the cable cover might come off.

Covering the connector panel

When installing the projector to the ceiling, the accessory cable cover can be used to cover the connectors after removing the cut-away parts.

- ① Use pliers or similar to break the perforated sections of the cut-away parts.

Perforated sections

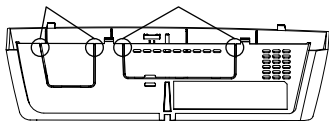

- ② Work the cut-away parts back and forth several times to break the fixing tabs. Smooth off any jagged edges if necessary.

Hook2

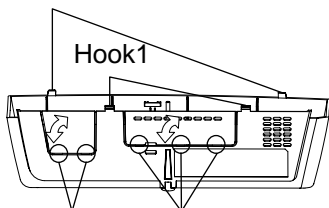

Fixing tabs Fixing tabs

- ③ Pass the mains lead through cut-away part S, pass the other cables through cut-away part L, and then insert the hook1 of the cable cover into the mounting holes in the projector.

- ④ Push in the hook 2 until it locks into place.

Cut-away part S

Cut-away part L

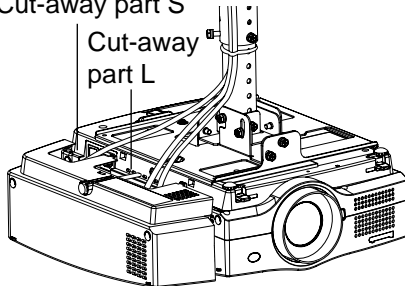

- ⑤ Tighten the screw by turning it clockwise.

Screw

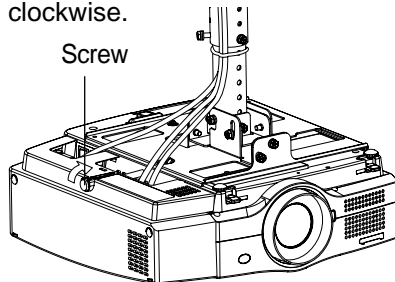

Refer to page 62 for details on removing the cable cover.

NOTE:

- Do not cover the air inlet ports when using the cable cover as stated above.
- Do not place any heavy objects on the cable cover to prevent it from falling.
- Do not bend the cables greatly, otherwise it will be difficult to attach the cable cover.
- Remove the cable cover when cleaning or replacing the air filter.

Replacing the projection lens

By replacing the projection lens with a lens that is sold separately, you can change the projection distance.

Removing the lens

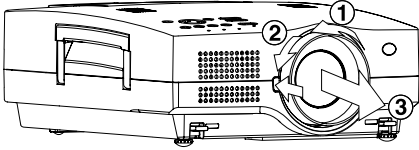

- ① Turn the projection lens anticlockwise until it stops.
- ② While pressing the lens release button, turn the projection lens anticlockwise again.
- ③ Remove the projection lens.

Installing the lens

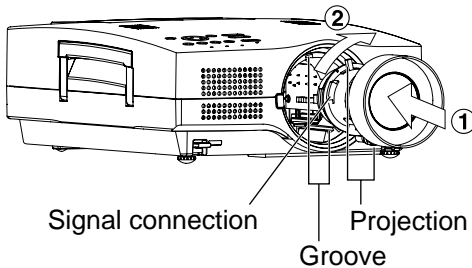

- ① Insert the other projection lens (sold separately) as far as it will go, while matching the projection to the groove.
- ② Turn the projection lens clockwise until a click is heard.

NOTE:

- Be sure to turn off the power before replacing the projection lens.
- Do not touch the signal connection. If any dust or lint gets onto the signal connection, the electrical contact may become poor.
- Do not touch the surface of the lens with your bare hands.
- Store the replaced projection lens away carefully to avoid subjecting it to excessive vibration or shock.
- Be sure to adjust "LENS SELECT" in the "LENS" menu when replacing the projection lens. (page 50)

Projection distance for each projection lens (sold separately)

Projector position

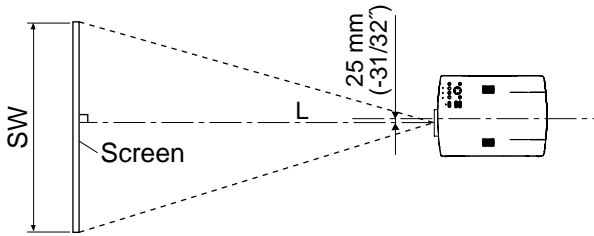
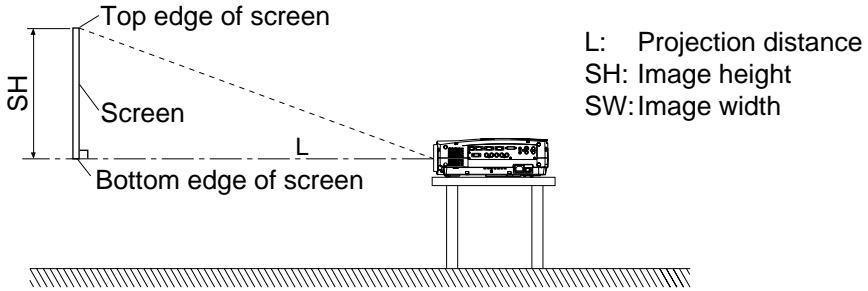

ET-LE10 (for short-distance projection)

Screen size (4:3)			Projection distance (L)	
Diagonal length	Height (SH)	Width (SW)	Wide (LW)	Telephoto (LT)
1.01 m(40")	0.61 m(2')	0.81 m(2'8")	1.1 m(3'7")	1.3 m(4'3")
1.27 m(50")	0.76 m(2'6")	1.02 m(3'4")	1.3 m(4'3")	1.7 m(5'6")
1.52 m(60")	0.91 m(3')	1.22 m(4')	1.6 m(5'2")	2.0 m(6'6")
1.77 m(70")	1.07 m(3'6")	1.42 m(4'8")	1.9 m(6'2")	2.4 m(7'10")
2.03 m(80")	1.22 m(4')	1.63 m(5'4")	2.2 m(7'2")	2.7 m(8'10")
2.28 m(90")	1.37 m(4'6")	1.83 m(6')	2.4 m(7'10")	3.1 m(10'2")
2.54 m(100")	1.52 m(5')	2.03 m(6'8")	2.7 m(8'10")	3.5 m(11'5")
3.81 m(150")	2.29 m(7'6")	3.05 m(10')	4.0 m(13'1")	5.3 m(17'4")
5.08 m(200")	3.05 m(10')	4.06 m(13'4")	5.4 m(17'8")	7.0 m(22'11")
6.35 m(250")	3.81 m(12'6")	5.08 m(16'8")	6.7 m(21'11")	8.8 m(28'10")
7.62 m(300")	4.57 m(15')	6.10 m(20')	8.1 m(26'6")	10.6 m(34'9")

ET-LE20 (for medium-distance projection)

Screen size (4:3)			Projection distance (L)	
Diagonal length	Height (SH)	Width (SW)	Wide (LW)	Telephoto (LT)
1.01 m(40")	0.61 m(2')	0.81 m(2'8")	2.1 m(6'10")	3.3 m(10'9")
1.27 m(50")	0.76 m(2'6")	1.02 m(3'4")	2.7 m(8'10")	4.2 m(13'9")
1.52 m(60")	0.91 m(3')	1.22 m(4')	3.2 m(10'5")	5.0 m(16'4")
1.77 m(70")	1.07 m(3'6")	1.42 m(4'8")	3.8 m(12'5")	5.9 m(19'4")
2.03 m(80")	1.22 m(4')	1.63 m(5'4")	4.3 m(14'1")	6.8 m(22'3")
2.28 m(90")	1.37 m(4'6")	1.83 m(6')	4.9 m(16')	7.7 m(25'3")
2.54 m(100")	1.52 m(5')	2.03 m(6'8")	5.4 m(17'8")	8.5 m(27'10")
3.81 m(150")	2.29 m(7'6")	3.05 m(10')	8.2 m(26'10")	12.9 m(42'3")
5.08 m(200")	3.05 m(10')	4.06 m(13'4")	11.0 m(36'10")	17.2 m(56'5")
6.35 m(250")	3.81 m(12'6")	5.08 m(16'8")	13.8 m(45'3")	21.6 m(70'10")
7.62 m(300")	4.57 m(15')	6.10 m(20')	16.5 m(54'1")	26.0 m(85'3")

ET-LE30 (for long-distance projection)

Screen size (4:3)			Projection distance (L)	
Diagonal length	Height (SH)	Width (SW)	Wide (LW)	Telephoto (LT)
1.01 m(40")	0.61 m(2')	0.81 m(2'8")	3.4 m(11'1")	4.6 m(15'1")
1.27 m(50")	0.76 m(2'6")	1.02 m(3'4")	4.2 m(13'9")	5.8 m(19')
1.52 m(60")	0.91 m(3')	1.22 m(4')	5.0 m(16'4")	6.9 m(22'7")
1.77 m(70")	1.07 m(3'6")	1.42 m(4'8")	5.8 m(19')	8.1 m(26'6")
2.03 m(80")	1.22 m(4')	1.63 m(5'4")	6.6 m(21'7")	9.2 m(30'2")
2.28 m(90")	1.37 m(4'6")	1.83 m(6')	7.4 m(24'3")	10.4 m(34'1")
2.54 m(100")	1.52 m(5')	2.03 m(6'8")	8.2 m(26'10")	11.5 m(37'8")
3.81 m(150")	2.29 m(7'6")	3.05 m(10')	12.2 m(40')	17.3 m(56'9")
5.08 m(200")	3.05 m(10')	4.06 m(13'4")	16.3 m(53'5")	23.0 m(75'5")
6.35 m(250")	3.81 m(12'6")	5.08 m(16'8")	20.4 m(66'11")	28.7 m(94'1")
7.62 m(300")	4.57 m(15')	6.10 m(20')	24.4 m(80')	34.5 m(113'2")

Setting-up dimensions which are not given in the table can be calculated using the formulas below.

SD (m): Screen size (diagonal)

LW: Projection distance for the wide lens position

LT: Projection distance for the telephoto lens position

Model No. of projection lens	Aspect ratio	Methods of calculation of Projection distance (L) Unit: mm
Zoom lens	ET-LE10 (1.3-1.7:1)	4:3 LW = $0.027 \times SD / 0.0254 - 0.0523$ LT = $0.0355 \times SD / 0.0254 - 0.0509$
		16:9 LW = $0.0294 \times SD / 0.254 - 0.0523$ LT = $0.0387 \times SD / 0.0254 - 0.0509$
	ET-LE20 (2.6-4.2:1)	4:3 LW = $0.0554 \times SD / 0.0254 - 0.134$ LT = $0.0871 \times SD / 0.0254 - 0.136$
		16:9 LW = $0.0604 \times SD / 0.254 - 0.134$ LT = $0.0949 \times SD / 0.254 - 0.136$
	ET-LE30 (4.0-5.6:1)	4:3 LW = $0.0809 \times SD / 0.0254 + 0.104$ LT = $0.1147 \times SD / 0.0254 + 0.096$
		16:9 LW = $0.0881 \times SD / 0.0254 + 0.104$ LT = $0.1250 \times SD / 0.0254 + 0.096$

Specifications

Power supply:	100 V - 240 V ~, 50 Hz/60 Hz
Power consumption:	380 W [During standby (when fan is stopped): approx. 11 W, during "WEB STANDBY" mode: approx. 40W]
Amps:	4.5 A - 2.0 A
LCD panel:	
Panel size (diagonal):	1.0 type (25.4 mm)
Aspect ratio:	4:3
Micro lens array:	Available
Display method:	3 transparent LCD panels (RGB)
Drive method:	Active matrix method
Pixels:	786 432 (1 024 x 768) x 3 panels
Lens:	Electronic zoom (1 - 1.2) / focus F 1.7 - 2.1 f 40.7 mm - 52.8 mm
Lamp:	UHM lamp (270 W)
Luminosity:	3 200 lm
Scanning frequency (for RGB signals):	
Horizontal scanning frequency:	15 kHz - 91 kHz
Vertical scanning frequency:	50 Hz - 87 Hz
Dot clock frequency:	Less than 108 MHz
YPbPr signals:	480i, 576i, 480p, 576p, 1 080/60i, 1 080/50i, 720/60p
Color system:	7 (NTSC/NTSC 4.43/PAL/PAL-M/PAL-N/ PAL60/SECAM)
Projection size:	1 016 mm - 7 620 mm (40" - 300")
Throw distance:	1.6 m - 16.0 m (5'2" - 52'5")
Optical axis shift:	10:0 (fixed)
Screen aspect ratio:	4:3
Installation:	Front/Rear/Ceiling/Desk (menu selection)
Speaker:	4 cm x 3 cm oval x 2
Max. useable volume output:	2 W (stereo)
Connectors	
DVI-D IN:	Single-line, DVI-D 24 pin
RGB IN/OUT:	Dual-line, D-sub HD 15-pin (female) [One line is available for input and output, selectable using an on-screen menu] Single-line, BNCx5
During YPbPr input/output:	
Y:	1.0 V [p-p] (Including sync), 75 Ω
PB, PR :	0.7 V [p-p], 75 Ω
During RGB input/output:	
R.G.B.:	0.7 V [p-p], 75 Ω
G.SYNC:	1.0 V [p-p], 75 Ω

HD/SYNC:	TTL, automatic positive/negative polarity compatible
VD:	TTL, automatic positive/negative polarity compatible
RGB AUDIO IN:	Single-line, 0.5 V [rms] M3 jack (Stereo MINI)
VIDEO IN:	Single-line, RCA pin jack 1.0 V [p-p], 75 Ω
S-VIDEO IN:	Single-line, Mini DIN 4-pin Y 1.0 V [p-p], C 0.286 V [p-p], 75 Ω
AUDIO IN (for S-VIDEO/VIDEO):	Single-line, 0.5 V [rms] RCA pin jack x 2 (L-R)
AUDIO OUT:	Single-line, 0.5 V [rms] M3 jack (Stereo MINI) (Monitor output/stereo compatible) 0 V [rms] - 1.0 V [rms] (variable)
SERIAL:	D-sub 9-pin for external control (RS-232C)
REMOTE:	D-sub 9-pin for external control
Wired LAN:	RJ-45 x 1, 10Base-T/100Base-TX for network connection

Cabinet:	Moulded plastic (PC/ABS)
Dimensions:	
Width:	290 mm (11-13/32")
Height:	137 mm (5-3/8")
Length:	406 mm (15-31/32") (without lens cover)

Weight:	5.8 kg (12.8 lbs.)
Operating environment:	
Temperature:	0 °C - 40 °C (32 °F - 104 °F) [When the "FAN CONTROL" is set to "HIGH" (page 48): 0 °C - 35 °C (32 °F - 95 °F)]
Humidity:	20% - 80% (no condensation)
Certifications:	UL60950, C-UL FCC Class B

<Remote control unit>

Power supply:	3 V DC (AAA battery x2)
Operating range:	Approx. 7 m (23') (when operated directly in front of signal receptor)
Weight:	95 g (3.4 ozs.) (including batteries)
Dimensions:	
Width:	45 mm (1-3/4")
Length:	145 mm (5-11/16")
Height:	23 mm (-7/8")

<Options>

Ceiling mount bracket	ET-PK780
Ceiling mount bracket (for low ceilings)	ET-PK780S
Wireless mouse receiver	ET-RMRC2
Projection lens	ET-LE10 (for a short-distance projection) ET-LE20 (for a medium-distance projection) ET-LE30 (for a long-distance projection)

Appendix

List of compatible signals

Mode	Display resolution (dots)*1	Scanning frequency		Dot clock frequency (MHz)	Picture quality*2	Resizing*3	Format
		H (kHz)	V (Hz)				
NTSC/NTSC4.43/ PAL-M/PAL60	720 x 480i	15.7	59.9		A	OK	Video/S-Video
PAL/PAL-N/SECAM	720 x 576i	15.6	50.0		A	OK	Video/S-Video
480i	720 x 480i	15.7	59.9	13.5	A	OK	YPbPr/RGB
576i	720 x 576i	15.6	50.0	13.5	A	OK	YPbPr/RGB
480p	720 x 483	31.5	59.9	27.0	A	OK	YPbPr/RGB
576p	720 x 576	31.3	50.0	27.0	A	OK	YPbPr/RGB
1 080/60i	1 920 x 1 080i	33.8	60.0	74.3	A		YPbPr/RGB
1 080/50i	1 920 x 1 080i	28.1	50.0	74.3	A		YPbPr/RGB
720/60p	1 280 x 720	45.0	60.0	74.3	A		YPbPr/RGB
VGA400	640 x 400	31.5	70.1	25.2	A	OK	RGB
	640 x 400	37.9	85.1	31.5	A	OK	RGB
VGA480 *4	640 x 480	31.5	59.9	25.2	A	OK	RGB/DVI
	640 x 480	35.0	66.7	30.2	A	OK	RGB
	640 x 480	37.9	72.8	31.5	A	OK	RGB
	640 x 480	37.5	75.0	31.5	A	OK	RGB
	640 x 480	43.3	85.0	36.0	A	OK	RGB
SVGA	800 x 600	35.2	56.3	36.0	A	OK	RGB
	800 x 600	37.9	60.3	40.0	A	OK	RGB/DVI
	800 x 600	48.1	72.2	50.0	A	OK	RGB
	800 x 600	46.9	75.0	49.5	A	OK	RGB
	800 x 600	53.7	85.1	56.3	A	OK	RGB
MAC16	832 x 624	49.7	74.6	57.3	A	OK	RGB
XGA *4	1 024 x 768	48.4	60.0	65.0	AA		RGB/DVI
	1 024 x 768	56.5	70.1	75.0	AA		RGB
	1 024 x 768	60.0	75.0	78.8	AA		RGB
	1 024 x 768	68.7	85.0	94.5	AA		RGB
	1 024 x 768i	35.5	87.0	44.9	AA		RGB
MXGA	1 152 x 864	64.0	71.2	94.2	A		RGB
	1 152 x 864	67.5	74.9	108.0	A		RGB
	1 152 x 864	76.7	85.0	121.5	B		RGB
MAC21	1 152 x 870	68.7	75.1	100.0	A		RGB
MSXGA *4	1 280 x 960	60.0	60.0	108.0	A		RGB/DVI
SXGA *4	1 280 x 1 024	64.0	60.0	108.0	A		RGB/DVI
	1 280 x 1 024	80.0	75.0	135.0	B		RGB
	1 280 x 1 024	91.1	85.0	157.5	B		RGB
	1 400 x 1 050	64.0	60.0	108.0	A		RGB
UXGA *4	1 600 x 1 200	75.0	60.0	162.0	B		RGB

*1 The "i" appearing after the resolution indicates an interlaced signal.

*2 The following symbols are used to indicate picture quality.

AA Maximum picture quality can be obtained.

A Signals are converted by the image processing circuit before picture is projected.

B Some loss of data occurs to make projection easier.

*3 Signals with "OK" in the "Resizing" column can be set using the "RESIZING" command in the "POSITION" menu. (page 45)

*4 Signals that are compatible with the "FRAME LOCK" function. (page 45)

Using the REMOTE connector

Using the REMOTE connector which is on the connector panel of the projector, it is possible to operate the projector from an external location from where infrared remote control signals cannot be received, by using a remote control panel.

Pin assignments and signal names

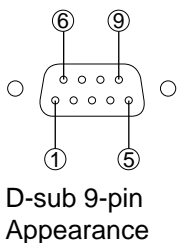

Pin No.	Signal Name	Contents
①	GND	Ground
②	POWER	Power ON
③	INPUT SEL3	Input signal select3
④		NC
⑤	INPUT SEL1	Input signal select1
⑥	INPUT SEL2	Input signal select2
⑦		NC
⑧		NC
⑨	ENABLE	Enables remote terminal control

Short pin ① and pin ⑨ when controlling.

Power ON/OFF

Pin No.	Setting	
②-①	Short	Open
Lamp	ON	OFF (standby)

Switching the input mode

Pin No.	Setting					
③-①	Open	Open	Short	Short	Short	Open
⑤-①	Open	Short	Open	Open	Short	Open
⑥-①	Open	Open	Short	Open	Open	Short
Input Signal	RGB1	RGB2	RGB3	VIDEO	S-VIDEO	DVI

NOTE:

- The POWER, RGB and VIDEO buttons on the remote control unit and projector will not operate when pins ① and ⑨ are shorted. RS-232C commands will also be ignored.
- Do not short pins ①, ②, ③, ⑤, or ⑥ when pin ⑨ is open. If this is done, the projector will ignore signals from the remote control unit.

Using the SERIAL connector

The serial connector which is on the connector panel of the projector conforms to the RS-232C interface specification, so that the projector can be controlled by a personal computer which is connected to this connector.

Connection

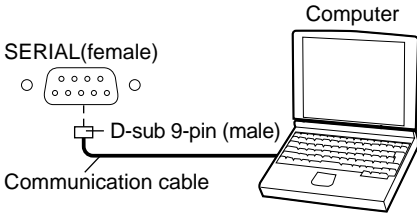

NOTE:

- Use a proper communication cable which is suitable for the personal computer to connect the serial connector and the personal computer.

Pin assignments and signal names

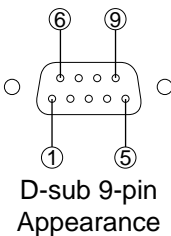

Pin No.	Signal name	Contents
①		NC
②	TXD	Transmitted data
③	RXD	Received data
④		NC
⑤	GND	Ground
⑥	DSR	Connected internally
⑦	CTS	
⑧	RTS	
⑨		NC

Communications settings

Signal level	RS-232C
Sync. method	Asynchronous
Baud rate	9 600 bps
Parity	None
Character length	8 bits
Stop bit	1 bit
X parameter	None
S parameter	None

Basic format

The data sent from the computer to the projector is transmitted in the format shown below.

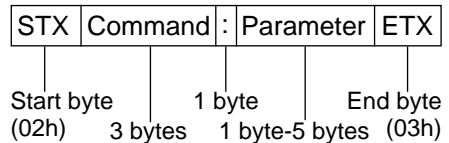

NOTE:

- The projector can not receive the command for 10 seconds after the lamp is switched on. Wait 10 seconds before sending the command.
- If sending multiple commands, check that a response has been received from the projector for one command before sending the next command.
- When a command which does not require parameters is sent, the colon (:) is not required.
- If an incorrect command is sent from the personal computer, the "ER401" command will be sent from the projector to the personal computer.

Control commands

The commands which the personal computer can use to control the projector are shown in the following table.

Command	Control Contents	Remarks
PON	Power ON	In standby mode, all commands other than the PON command are ignored. <ul style="list-style-type: none"> • The PON command is ignored during lamp ON control. • If a PON command is received while the cooling fan is operating after the lamp has switched off, the lamp is not turned back on again straight away, in order to protect the lamp.
POF	Power OFF	
AVL	Volume	Parameter 000-063 (Adjustment value 0-63)
IIS	Input signal selection	Parameter VID=VIDEO SVD=S-VIDEO RG1=RGB1 RG2=RGB2 RG3=RGB3 DVI=DVI
Q\$\$	Lamp ON condition query	Callback 0 = Standby 1 = Lamp ON control active 2 = Lamp ON 3 = Lamp OFF control active
OSH	Shutter function	Operation will be switched between ON and OFF each time the command is sent. Do not switch operation ON and OFF after only short periods of time.

Cable specifications

(When connected to a personal computer)

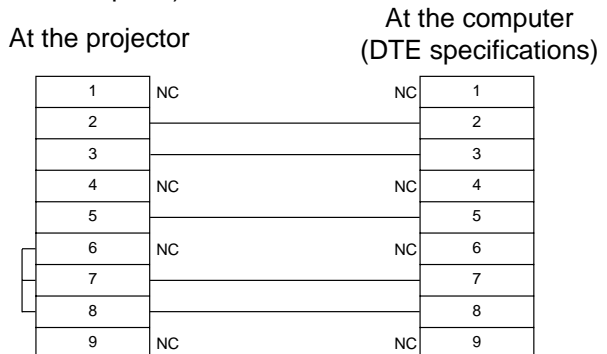

Others

Pin assignments

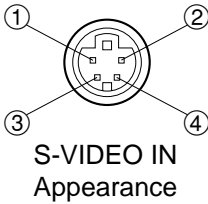

Pin No.	Signal
①	Earth (Luminance signal)
②	Earth (Color signal)
③	Luminance signal
④	Color signal

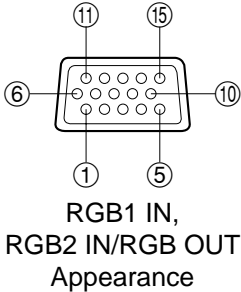

Pin No.	Signal
①	R/P _R
②	G/G-SYNC/Y
③	B/P _B
⑫	SDA
⑬	HD/SYNC
⑭	VD
⑮	SCL

Pin ⑨ is spare. Pins ④-⑧, ⑩ and ⑪ are for earth.

Pins ⑫ and ⑮ functions are only valid when supported by the computer.

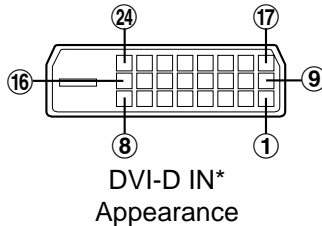

*Interface with TMDS connector on a personal computer

Pin No.	Signal	Pin No.	Signal
①	T.M.D.S data 2-	⑬	T.M.D.S data 3+
②	T.M.D.S data 2+	⑭	+5 V
③	T.M.D.S data 2/4 shield	⑮	Earth
④	T.M.D.S data 4-	⑯	Hot plug sense
⑤	T.M.D.S data 4+	⑰	T.M.D.S data 0-
⑥	DDC clock	⑱	T.M.D.S data 0+
⑦	DDC data	⑲	T.M.D.S data 0/5 shield
⑧	—	⑳	T.M.D.S data 5-
⑨	T.M.D.S data 1-	㉑	T.M.D.S data 5+
⑩	T.M.D.S data 1+	㉒	T.M.D.S clock shield
⑪	T.M.D.S data1/3 shield	㉓	T.M.D.S clock+
⑫	T.M.D.S data 3-	㉔	T.M.D.S clock-

Projection dimensions calculation methods

If the screen size (diagonal) is SD (m), then the following formula is used to calculate the projection distance for the wide lens position (LW) and the projection distance for the telephoto lens position (LT).

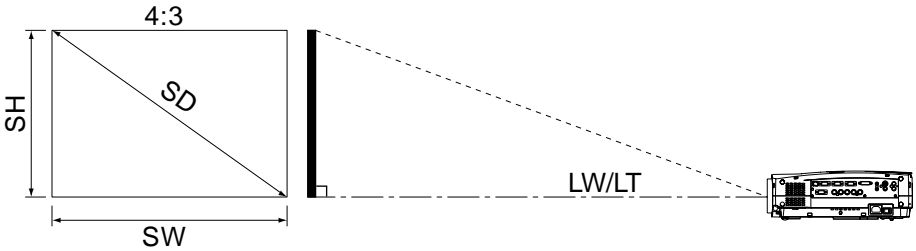

Minimum Projection Distance	$LW=0.0407 \times SD / 0.0254 - 0.080$
Maximum Projection Distance	$LT=0.0538 \times SD / 0.0254 - 0.0774$

For 16:9 aspect ratios, the following formula can be used to calculate the projection distance.

Minimum Projection Distance	$LW=0.0443 \times SD / 0.0254 - 0.080$
Maximum Projection Distance	$LT=0.0586 \times SD / 0.0254 - 0.0774$

*The values obtained from the formulas above are approximate.

Dimensions

<Units: mm (inch)>

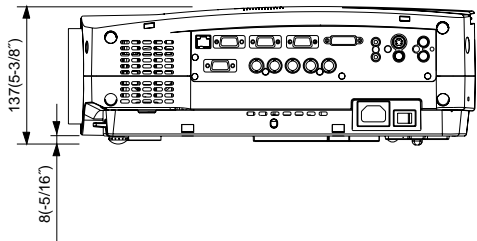
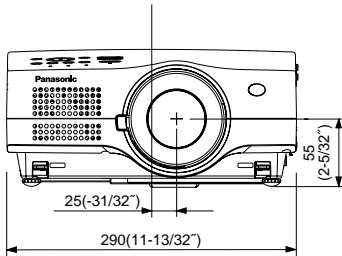
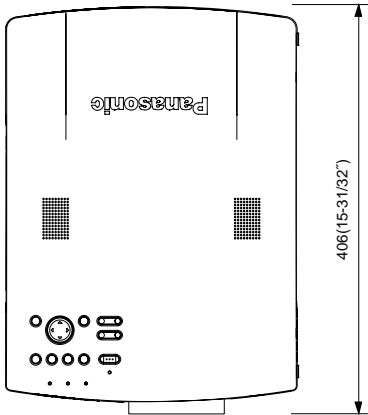

Trademark acknowledgements

- VGA and XGA are trademarks of International Business Machines Corporation.
- Macintosh is a registered trademark of Apple Computer, Inc.
- S-VGA is a registered trademark of the Video Electronics Standards Association.

All other trademarks are the property of the various trademark owners.

These Operating Instructions are printed on recycled paper.

NOTES IMPORTANTES CONCERNANT LA SECURITE

**AVERTISSEMENT: POUR REDUIRE LES RISQUES DE FEU OU DE CHOC
ÉLECTRIQUE, NE PAS EXPOSER CE PRODUIT À L'EAU
OU À L'HUMIDITÉ**

Alimentation: Ce projecteur LCD est conçu pour fonctionner sur secteur de 100 V - 240 V, 50 Hz/60 Hz seulement.

ATTENTION: Le cordon d'alimentation secteur fourni avec le projecteur peut être utilisé uniquement pour une alimentation électrique de 125 V, 7 A maximum. Si on veut l'utiliser avec une tension ou un courant plus forts, on doit se procurer un autre cordon d'alimentation de 250 V. Si on utilise le cordon fourni sous ces conditions, risque de provoquer un incendie.



Le symbole de la flèche en forme d'éclair, dans un triangle, avertit l'utilisateur de la présence de "tensions dangereuses" à l'intérieur du produit qui peuvent être de force suffisante pour constituer un risque de choc électrique aux personnes.



Le point d'exclamation dans un triangle avertit l'utilisateur de la présence d'instructions importantes concernant l'utilisation et l'entretien (réparation) dans la littérature accompagnant le produit.

ATTENTION: Cet appareil est équipé d'une fiche de courant à trois broches avec mise à la terre. Ne pas retirer la broche de mise à la masse de la fiche.

Cette fiche ne pourra être utilisée que dans une prise avec mise à la terre. Ceci est une précaution sécuritaire. S'il est impossible d'insérer la fiche dans la prise, s'adresser à un électricien. Ne pas annuler la protection de la fiche à mise à la terre.

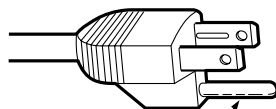

Ne pas retirer

Others

AVERTISSEMENT:

- Ne peut être utilisé dans une salle d'ordinateurs telle que définie dans la norme ANSI/NFPA 75 Standard for Protection of Electronic Computer/Data Processing Equipment.

Précautions de sécurité

AVERTISSEMENT

Si l'on remarque une émission de fumée, d'odeurs suspectes ou de bruits provenant du projecteur, débrancher la fiche du cordon d'alimentation de la prise de courant.

- Ne pas continuer d'utiliser le projecteur dans ces cas, autrement cela peut entraîner un incendie ou des chocs électriques.
- Après s'être assuré que de la fumée ne se dégage plus, s'adresser à un centre technique agréé et demander que les réparations nécessaires soient faites.
- Le fait de réparer le projecteur soi-même est très dangereux, et ne doit jamais être fait.

Ne pas installer ce projecteur dans un endroit qui n'est pas assez résistant pour supporter le poids du projecteur.

- Si l'emplacement d'installation n'est pas assez résistant, le projecteur risque de tomber et causer de graves blessures et (ou) des dommages.

Demander à un technicien qualifié d'installer le projecteur par exemple s'il est installé au plafond.

- Si l'installation n'est pas faite correctement, cela peut entraîner des blessures ou des chocs électriques.

Si de l'eau ou des objets étrangers entrent dans le projecteur, si le projecteur tombe, ou si le boîtier est endommagé, éteindre l'appareil et débrancher immédiatement la fiche du cordon d'alimentation de la prise de courant.

- Si l'on continue d'utiliser le projecteur dans cette condition, cela peut entraîner un incendie ou des chocs électriques.
- S'adresser à un centre technique agréé pour que les réparations nécessaires puissent être faites.

Ne pas surcharger la prise de courant.

- Si l'alimentation est surchargée (par exemple, par l'utilisation de trop d'adaptateurs), cela risque de faire surchauffer le projecteur et peut entraîner un incendie.

Ne pas retirer le capot ou le modifier.

- Des hautes tensions qui peuvent causer de graves blessures sont présentes à l'intérieur du projecteur.
- Pour toute inspection, réglage ou réparation, s'adresser à un centre technique agréé.

Nettoyer la fiche du cordon d'alimentation régulièrement afin d'éviter toute accumulation de poussière.

- Si de la poussière s'accumule sur la fiche du cordon d'alimentation, l'humidité peut endommager l'isolant et entraîner un incendie. Débrancher la fiche du cordon d'alimentation de la prise de courant et l'essuyer avec un tissu sec.
- Si le projecteur n'est pas utilisé pendant une période prolongée, débrancher la fiche du cordon d'alimentation de la prise de courant.

Faire attention à ne pas endommager le cordon d'alimentation.

- Ne pas endommager le cordon d'alimentation, ne pas le modifier, ne pas le placer sous des objets lourds, ne pas le chauffer, ne pas le placer près d'objets chauffants, ne pas le tordre, ne pas le plier ou le tirer excessivement et ne pas le rouler en boule.
- Si le cordon d'alimentation est endommagé, cela peut entraîner un incendie et des chocs électriques.
- Si le cordon d'alimentation est endommagé, le faire réparer par un centre technique agréé.

Ne pas manipuler le cordon d'alimentation avec les mains mouillées.

- Cela peut entraîner des chocs électriques.

Brancher la fiche du cordon d'alimentation fermement dans la prise de courant.

- Si la fiche n'est pas complètement insérée, cela peut entraîner des chocs électriques ou la faire surchauffer.
- Si la fiche est endommagée ou la plaque de la prise est desserrée, elles ne devraient pas être utilisées.

Ne pas placer le projecteur sur des surfaces instables.

- Si le projecteur est placé sur une surface qui est inclinée ou instable, il risque de tomber ou de se renverser et cela peut causer des blessures ou des dommages.

Ne pas placer le projecteur dans l'eau ou ne pas le laisser se mouiller.

- Sinon cela peut causer un incendie ou des chocs électriques.

Ne pas placer des récipients de liquide sur le projecteur.

- Si de l'eau se renverse sur le projecteur ou pénètre dans celui-ci, il y aura risque d'incendie ou d'électrocution.
- Si de l'eau entre à l'intérieur du projecteur, entrer en contact avec un centre technique agréé.

Ne pas mettre d'objets étrangers dans le projecteur.

- Ne pas insérer d'objets métalliques ou inflammables dans les orifices de ventilation ou les faire tomber sur le projecteur, car cela peut causer un incendie ou des chocs électriques.

Garder les piles hors de portée des enfants.

- Si les piles sont ingérées, il y aura risque de décès par étouffement. En cas d'ingestion des piles, consulter immédiatement un médecin.

Veiller à ce que les bornes + et - des piles n'entrent pas en contact avec des objets métalliques tels que colliers ou épingles à cheveux.

- Sinon, les piles risquent de fuir, de surchauffer, d'exploser ou de prendre feu.
- Ranger les piles dans un sac en plastique, et ne pas les ranger à proximité d'objets métalliques.

Pendant un orage, ne pas toucher le projecteur ou le câble.

- Il y a risque d'électrocution.

Ne pas utiliser l'appareil dans un bain ou une douche.

- Il y a risque d'incendie ou d'électrocution.

Ne pas regarder directement dans l'objectif pendant que le projecteur fonctionne.

- Une lumière intense est émise par l'objectif du projecteur. Si l'on regarde directement dans cette lumière, elle risque de causer des blessures et de graves lésions aux yeux.
- Veiller particulièrement à ce que les enfants ne regardent pas dans l'objectif. En outre, éteindre le projecteur si on le laisse sans surveillance.

Garder la télécommande hors de portée des enfants, et ne pas regarder directement dans le rayon laser; ne pas pointer le rayon vers d'autres personnes.

- Si l'on pointe directement vers les yeux le rayon laser émis par la télécommande, ceci risque d'endommager les yeux.

Ne pas placer les mains ou autres objets près de l'orifice de sortie d'air.

- De l'air chaud sort par l'orifice de sortie d'air. Ne pas placer les mains, le visage, ou d'autres objets qui ne peuvent résister à la chaleur près de cette sortie d'air, sinon des brûlures ou des dommages risqueraient de s'ensuivre.

Le remplacement de l'unité de lampe ne devrait être effectué que par un technicien qualifié.

- Le bloc de lampe a une haute pression interne. S'il est mal manipulé, une explosion peut s'ensuivre
- Le bloc de lampe peut être facilement endommagé s'il est cogné contre des objets durs ou si on le laisse tomber, pouvant entraîner des blessures ou des mauvais fonctionnements.

Lors du remplacement de la lampe, la laisser refroidir pendant au moins une heure avant de la manipuler.

- Le couvercle de la lampe devient très chaud, et on risque de se brûler si on le touche.

Avant de remplacer la lampe, veiller à débrancher la fiche du cordon d'alimentation de la prise de courant.

- Il y a risque d'électrocution ou d'explosion.

Attention

Ne pas obstruer les orifices d'entrée et de sortie d'air.

- Cela risque de faire surchauffer le projecteur, et causer un incendie ou endommager le projecteur.

- Ne pas installer le projecteur dans des endroits étroits, mal ventilés tels que des placards ou des étagères.

Ne pas installer le projecteur dans des endroits humides ou poussiéreux ou dans des endroits où le projecteur peut entrer en contact avec de la fumée ou la vapeur.

- L'utilisation du projecteur dans de telles conditions peut causer un incendie ou des chocs électriques.

Pour débrancher le cordon d'alimentation, tenir la fiche et non pas le cordon.

- Si le cordon d'alimentation est tiré, le cordon sera endommagé et cela peut causer un incendie, des courts-circuits ou des chocs électriques sérieux.

Débrancher toujours tous les câbles avant de déplacer le projecteur.

- Le fait de déplacer le projecteur avec des câbles branchés peut endommager les câbles, ce qui pourrait causer un incendie ou des chocs électriques.

Ne pas placer d'objets lourds sur le projecteur.

- Cela peut déséquilibrer le projecteur et le faire tomber, ce qui peut entraîner des dommages ou des blessures.

Ne pas court-circuiter, chauffer ou démonter les piles, et ne pas les mettre dans l'eau ou dans le feu.

- Sinon, les piles risqueront de surchauffer, de fuir, d'exploser ou de prendre feu, et donc de causer des brûlures ou d'autres blessures.

Lorsqu'on insère les piles, veiller à ce que les polarités (+ et -) soient bien respectées.

- Si l'on insère les piles incorrectement, elles risqueront d'exploser ou de fuir, ce qui peut causer un incendie, des blessures ou une contamination du logement des piles et de la zone environnante.

Utiliser uniquement les piles spécifiées.

- Si l'on utilise des piles incorrectes, elles risqueront d'exploser ou de fuir, ce qui peut causer un incendie, des blessures ou une contamination du logement des piles et de la zone environnante.

Ne pas mélanger des piles usées et des piles neuves.

- Si l'on insère les piles incorrectement, elles risqueront d'exploser ou de fuir, ce qui peut causer un incendie, des blessures ou une contamination du logement des piles et de la zone environnante.

Isoler la pile à l'aide d'adhésif ou autre avant de la mettre au rebut.

- Si la pile entre en contact avec des objets métalliques ou d'autres piles, elle peut prendre feu ou éclater.

Ne pas peser de tout son poids sur ce projecteur.

- On risque de tomber ou de casser l'appareil, ce qui peut causer des blessures.
- Veiller tout particulièrement à ce que les enfants ne se tiennent pas debout ou ne s'asseyent pas sur le projecteur.

Ne pas soulever le projecteur en le tenant par le couvercle du câble.

- Sinon, le couvercle du câble risquera de se détacher et le projecteur risquera de tomber et de causer des blessures.

Débrancher la fiche du cordon d'alimentation de la prise de courant comme mesure de sécurité avant d'effectuer tout nettoyage.

- Sinon cela peut causer des chocs électriques.

Demander à un centre technique agréé de nettoyer l'intérieur du projecteur au moins une fois par an.

- S'il n'est pas nettoyé et que de la poussière s'accumule à l'intérieur du projecteur, cela peut causer un incendie ou des problèmes de fonctionnement.
- Il est recommandé de nettoyer l'intérieur du projecteur avant l'arrivée de la saison humide. Demander au centre technique agréé le plus proche de nettoyer le projecteur lorsque cela est requis. Se renseigner auprès du centre technique agréé pour le coût du nettoyage.

Nous faisons tous les efforts possibles afin de préserver l'environnement. Prière de rapporter l'appareil, s'il n'est pas réparable, à votre revendeur ou à un centre de recyclage.

Avant l'utilisation

Précaution à prendre lors du déplacement du projecteur

Veiller à bien mettre le capuchon d'objectif en place avant de déplacer le projecteur.

La lentille de projection est extrêmement sensible aux vibrations et aux chocs. Veiller à ne pas la soumettre à des vibrations ou à des chocs excessifs lors du déplacement du projecteur.

Avertissements concernant l'installation

Éviter de l'installer dans les endroits sujets à des vibrations ou à des chocs.

Les pièces internes peuvent être endommagées, ce qui peut causer des pannes ou des accidents.

Ne pas installer le projecteur près de lignes d'alimentation électrique à haute tension ou de moteurs.

Le projecteur peut être soumis à des interférences électromagnétiques.

Si le projecteur est installé au plafond, demander à un technicien qualifié de faire tous les travaux d'installation.

Il faut acheter le kit d'installation séparé (numéro de modèle: ET-PK780).

En outre, tous les travaux d'installation doivent être exécutés uniquement par un technicien qualifié.

Si l'on utilise ce projecteur à un endroit élevé (au-dessus de 1 400 m), régler le "VENTILATEUR" sur "HAUTE" (se référer à la page 48).

Sinon, des anomalies pourront se produire.

Notes sur l'utilisation

Afin d'obtenir la meilleure qualité d'image

Fermer les rideaux ou les volets de toutes les fenêtres et éteindre les lampes fluorescentes situées à proximité de l'écran afin que la lumière extérieure ou la lumière des lampes intérieures n'éclaire pas l'écran.

Ne pas toucher aux surfaces de l'objectif avec les mains nues.

Si la surface de l'objectif est salie par des empreintes digitales ou autre, ceci sera agrandi et projeté sur l'écran. Par ailleurs, lorsque le projecteur n'est pas utilisé, rétracter l'objectif, puis la couvrir à l'aide du capuchon d'objectif.

Écran

N'appliquer aucun produit volatil qui risque de décolorer l'écran, et veiller à ce que l'écran ne soit pas sale ou endommagé.

Lampe

Il est possible qu'il faille remplacer la lampe plus tôt en raison de facteurs variables comme les caractéristiques de la lampe, des conditions d'utilisation et un environnement d'installation particuliers, notamment si elle est utilisée de façon continue pendant plus de 10 heures ou si l'alimentation est fréquemment mise en et hors circuit.

Affichage à cristaux liquides

L'affichage à cristaux liquides du projecteur a été fabriqué en utilisant une technologie de haute précision afin d'offrir une image très détaillée. Il est possible que parfois quelques pixels non actifs apparaissent sur l'écran sous forme de points fixes bleus, verts ou rouges. Bien noter que ceci n'affecte pas le bon fonctionnement de votre LCD.

Remplacement du bloc de lampe

AVERTISSEMENT

Le bloc de lampe ne devrait être remplacé que par un technicien qualifié.

Lors du remplacement de la lampe, la laisser refroidir pendant au moins une heure avant de la manipuler.

- Le couvercle de la lampe devient très chaud, et on risque de se brûler si on le touche.

Notes sur le remplacement du bloc de lampe

- La lampe produisant la lumière est en verre; il ne faut donc pas la laisser tomber ou la cogner contre des objets rigides, car elle risquerait d'éclater. Faire bien attention lorsqu'on manipule la lampe.
- Jeter la lampe usagée de la même manière qu'une lampe fluorescente.
- Il faut utiliser un tournevis Phillips pour déposer le bloc de lampe.

REMARQUE:

- Le projecteur n'est pas fourni avec un bloc de lampe de rechange. Demander les détails au revendeur. Numéro de produit du bloc de lampe: **ET-LA785**

ATTENTION:



- Ne pas utiliser un bloc de lampe avec un numéro de pièce autre que celui indiqué ci-dessus.

Période de remplacement du bloc de lampe

La lampe est un produit qui doit être remplacé. Même si la durée de vie complète de l'ampoule n'est pas encore épuisée, la luminosité de la lampe diminuera progressivement. Il faut donc remplacer périodiquement la lampe. L'intervalle de remplacement de la lampe prévu est de 1 500 heures; il est toutefois possible qu'il faille remplacer la lampe avant ce délai en raison d'éléments variables comme les caractéristiques particulières de la lampe, les conditions d'utilisation et l'environnement d'installation. Il est recommandé de toujours avoir un bloc de lampe de rechange prêt à l'emploi. La lampe s'éteindra automatiquement après environ 10 minutes lorsque la limite de 1 500 heures d'utilisation est atteinte, car le risque d'explosion de la lampe devient beaucoup plus grand passé cette limite.

REMARQUE:

- Les heures d'utilisation expliquées ci-dessus concernent l'utilisation lorsque "PUIS.LAMPE" dans le menu "OPTION" a été réglée sur "HAUTE". Si "PUIS.LAMPE" est réglée sur "FROIDE", la durée de vie de la lampe peut être allongée.
- Bien que le délai de 1 500 heures soit l'intervalle de remplacement prévu, l'obtention de cette durée n'est pas couverte par la garantie.

	Affichage à l'écran	Indicateur LAMP
		
Plus de 1 350 heures	Affiché pendant 30 secondes. L'affichage disparaît si l'on appuie sur n'importe quelle touche.	S'allume en rouge pendant que l'image est projetée et en mode d'attente.
Plus de 1 500 heures	Reste affiché jusqu'à ce qu'une touche quelconque soit pressée.	

Méthode de remplacement du bloc de lampe

REMARQUE:

- Si le temps d'utilisation de la lampe a dépassé 1 500 heures (lorsque "PUIS LAMPE" a été mis sur "HAUTE"), le projecteur passe en mode d'attente après environ dix minutes de fonctionnement. Dès lors, faire les étapes ⑦ à ⑫ à la page suivante dans les 10 minutes.

- ① Mettre hors circuit l'interrupteur **MAIN POWER** (alimentation principale) suivant la méthode donnée dans "Mise hors circuit de l'alimentation" à la page 26, puis débrancher la fiche du cordon d'alimentation de la prise de courant et vérifier que les pièces autour du bloc de lampe se sont refroidies.
- ② Utiliser un tournevis Phillips pour faire tourner les vis de fixation de la sortie d'air à l'arrière du projecteur et ouvrir la sortie d'air.

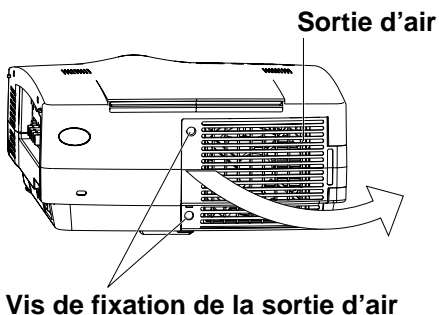

- ③ Utiliser un tournevis Phillips pour desserrer les deux vis de fixation du bloc de lampe jusqu'à ce que les vis tournent librement. Tenir la poignée du bloc de lampe et tirer doucement pour le sortir du projecteur.

Vis de fixation du bloc de lampe

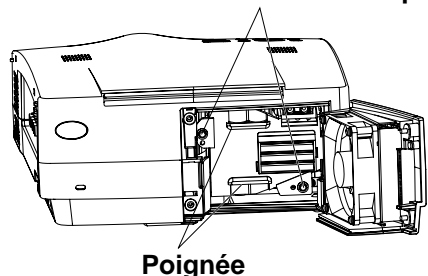

- ④ Insérer le nouveau bloc de lampe tout en s'assurant que la direction de l'insertion est correcte, puis utiliser un tournevis Phillips pour resserrer fermement les vis de fixation du bloc de lampe.

- ⑤ Refermer la sortie d'air, puis utiliser un tournevis Phillips pour bien resserrer les vis de fixation de la sortie d'air.

REMARQUE:

- Veiller à bien installer le bloc de lampe et la sortie d'air. S'ils ne sont pas bien installés, ils peuvent déclencher le circuit de protection, empêchant la mise en circuit de l'alimentation.

- ⑥ Insérer la fiche du cordon d'alimentation dans la prise de courant, puis appuyer sur l'interrupteur MAIN POWER (alimentation principale).

REMARQUE:

- Si l'indicateur POWER ne s'allume pas en rouge sur le projecteur lorsque l'interrupteur MAIN POWER est mis en circuit, remettre l'interrupteur MAIN POWER hors circuit et s'assurer que le bloc de lampe et la sortie d'air sont bien installés, puis remettre l'interrupteur MAIN POWER en circuit.

- ⑦ Appuyer sur la touche POWER pour projeter une image sur l'écran.

- ⑧ Appuyer sur la touche MENU pour faire apparaître l'écran de menu, et sélectionner "OPTION" en appuyant sur la touche ◀ ou ▶.



OPTION		
INFO ÉCRAN	NON	OUI
RECHERCHE AUTO	NON	OUI
SIGNAL AUTO	NON	OUI
SELECTION RGB2	ENTRÉE	SORTIE
RGB/YPbPr	RGB	YPbPr
VGA60/480P	VGA60	480P
COULEUR FOND	BLEU	NOIR
CINEMA REALITY	NON	OUI
PAGE SUIVANTE ↓		

SÉL. : [↑][↓]
AJT. : [←][→] ESC : [MENU]

- ⑨ Appuyer sur la touche ▼ et sélectionner "DURÉE LAMPE" en appuyant sur la touche ◀ ou ▶.



OPTION		
PAGE PRÉCÉDENTE ↑		
INSTALLATION	FAÇADE	ARRIÈRE
SOL/PLAFOND	SOL	PLAFOND
VENTILATEUR	STANDARD	HAUTE
PUIS. LAMPE	FROIDE	HAUTE
DURÉE LAMPE	10 H	
FONCTION 1	MUET	COR TRAP
TOUCHE CTRL	NON	OUI
AFFECTER N	TOUT	
POUVOIR AUTO FERM	IMMOBILISER	

SÉL. : [↑][↓]
AJT. : [←][→] ESC : [MENU]

- ⑩ Maintenir la touche ENTER enfoncée pendant environ 3 secondes.

REINIT. TEMPS LAMPE	
Coupe l'alimentation	
OUI	NON

"REINIT. TEMPS LAMPE" s'affiche.

- ⑪ Sélectionner "OUI" en appuyant sur la touche ◀ ou ▶ et appuyer sur la touche ENTER.

Le temps d'utilisation total du bloc de lampe est alors remis à zéro. Le bloc de lampe est éteint automatiquement, et le projecteur passe en mode d'attente.

REMARQUE:

- Si "NON" est sélectionné à l'étape ⑪, l'opération pour remettre le temps de la lampe à zéro sera annulée.

Panasonic®

Professional/Industrial Video

Panasonic Broadcast & Television Systems Company

Division of Matsushita Electric Corporation of America

One Panasonic Way 4E-7 Secaucus, NJ 07094 (201) 392-4443
3330 Cahuenga Blvd West Los Angeles, CA 90068 (323) 436-3500

Technical Support:

(800) 524-1448

(800) 526-6610

FAX: (201) 392-6514

E-Mail: pbtssupport@panasonic.com

Printed in Japan
S0604-0A